**EVALUATION OF
THE ALASKA
PRE-TRIAL
INTERVENTION
PROGRAM**

CR- Sent
8-2-89 mfl

116615
51911

N.E. Schafer



Alaska Justice Statistical Analysis Unit
JUSTICE CENTER
University of Alaska Anchorage

116615

**EVALUATION OF
THE ALASKA PRETRIAL INTERVENTION PROGRAM**

N.E. Schafer

116615

U.S. Department of Justice
National Institute of Justice

This document has been reproduced exactly as received from the person or organization originating it. Points of view or opinions stated in this document are those of the authors and do not necessarily represent the official position or policies of the National Institute of Justice.

Permission to reproduce this copyrighted material has been granted by

Justice Center
University of Alaska Anchorage

to the National Criminal Justice Reference Service (NCJRS).

Further reproduction outside of the NCJRS system requires permission of the copyright owner.

JUSTICE CENTER
Alaska Justice Statistical Analysis Unit
University of Alaska Anchorage

This report was funded by a grant from the Bureau of Justice Statistics, United States Department of Justice, which is not responsible for the contents. Any views expressed or implied are those of the author.

© 1988 by the Justice Center, University of Alaska Anchorage. All rights reserved.
Printed in the United States of America.

ACKNOWLEDGMENTS

This report could not have been completed without the cooperation of the Alaska Department of Public Safety under Commissioner Arthur English. Rick Judd and Paul Conger were generous with their advice and assistance in the retrieval of criminal history information for the recidivism data in this study. Victor Kapella and Lyle Personette provided important assistance with the difficult computer problems involved in the merging of data files.

Special thanks are due Sharilyn Mumaw, who was responsible for the collection and verification of the data over the life of the PTI program; to Janet Eidson, who organized this project; Allan Barnes, who labored over conflicting employment data; Phyl Booth, who produced the final document; and Antonia Moras, who edited several drafts of the report and approved the final version for publication.

The data for the report were available only because of the foresight and involvement of Patrick Conheady, former Chief of Pretrial Services, who understands the importance of research and of independent evaluations of new programs.

ALASKA COURT LOCATIONS

- Magistrate Only
- Resident district court judge(s)
- * Resident superior court judge(s)

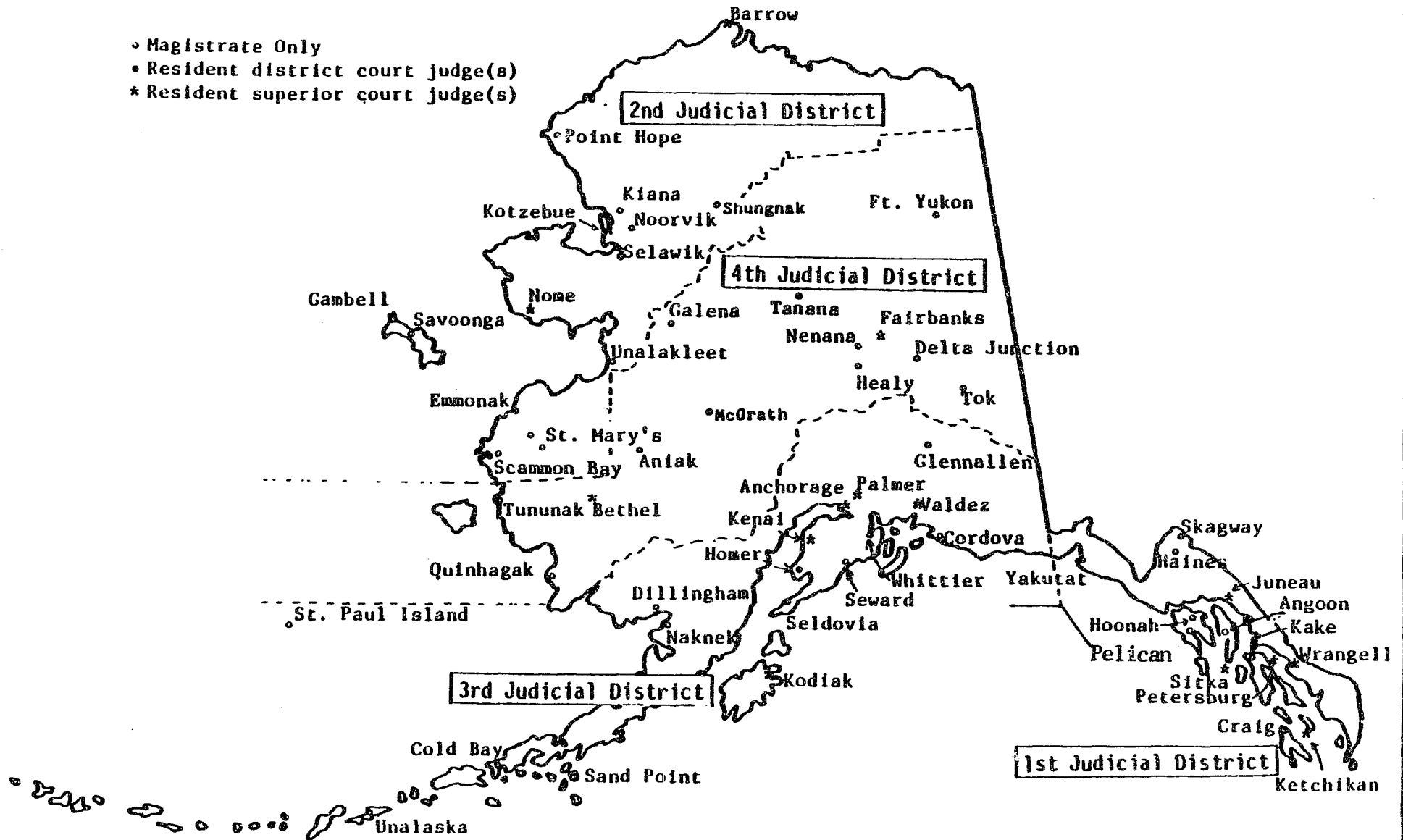

TABLE OF CONTENTS

| | Page |
|--|------|
| ACKNOWLEDGMENTS | |
| LIST OF FIGURES | |
| INTRODUCTION | 1 |
| LITERATURE REVIEW | 5 |
| BACKGROUND OF THE STUDY | 9 |
| A. The Alaska Justice System | 9 |
| B. A Brief History of Pretrial Diversion in Alaska | 12 |
| C. The Role of the Justice Center - History | 14 |
| RESEARCH METHODOLOGY | 17 |
| RESEARCH RESULTS | 21 |
| A. Personal and Social Characteristics | 21 |
| B. Legal Variables | 26 |
| C. Program Operation | 31 |
| RECIDIVISM IN THE PTI SAMPLE | 35 |
| SUMMARY AND RECOMMENDATIONS | 49 |
| BIBLIOGRAPHY | 55 |
| APPENDIX 1 | |
| APPENDIX 2 | |

LIST OF FIGURES

| | Page |
|--|------|
| Figure I. Annual Pretrial Intakes | 19 |
| Figure II. Client Profiles | 22 |
| Figure III. Racial/Ethnic Distribution by PTI Location | 24 |
| Figure IV. Frequency of Intake Offense Categories | 27 |
| Figure V. Type of Offender by Time Served in Program | 30 |
| Figure VI. Client Participation in Treatment Programs | 33 |
| Figure VII. Recidivism by Year | 36 |
| Figure VIII. Rearrest by Age | 38 |
| Figure IX. Recidivism Rates | 39 |
| Figure X. Success/Failure by Instant Offense | 43 |
| Figure XI. Pace of Recidivism by Legal Variables | 44 |
| A. Time from Intake Date to Rearrest by Offense Severity | |
| B. Time from Intake Date to Rearrest by Prior Record | |
| Figure XII. Recidivism by Program Disposition | 46 |

Introduction

The data assembled during the course of the Alaska Pretrial Intervention program between 1983 and 1986 provide a particularly complete basis to study a diversion program. The data base from the Alaska program is unique among such because it contains verified information on all participants in a three-year statewide pretrial diversion program. For the purposes of this study, which has been funded by the U.S. Bureau of Justice Statistics, the program data base was supplemented by the addition of criminal histories from Alaska criminal records, thus permitting follow-up of program participants for periods of two to five years after intake.

The evaluation of pretrial program data presented in this report includes aggregate information on the legal status of participants as well as their personal characteristics. The study assesses records of program participation, treatment requirements, restitution, and community service. The addition of criminal histories to the data file permits a preliminary evaluation of recidivism and an examination of personal and social characteristics which may be associated with rearrest.

The statewide nature of the Alaska Pretrial Intervention program provides an opportunity to study diversion from the criminal justice system as it operates in different localities under uniform guidelines. In other states pretrial diversion programs are site-specific, i.e., they operate in specific cities or counties and are governed by local guidelines and local policies and practices. Studies of these programs have been difficult to compare because the programs themselves may differ markedly in policies, target populations, purposes and goals, and program requirements. A study of a statewide program allows comparisons among different program sites operating under the same policies and permits an assessment of the ways in which both prosecutors and program staff adapt these policies to meet local

problems and concerns. In Alaska this is of special interest since communities in this state have distinctly different populations and problems: some are urban and some rural; some have a predominantly white population, some a predominantly Native one.

The Alaska Pretrial Intervention data base is also unique because it involved ongoing data collection, verification and computer entry by the Justice Center for the entire three-year period. Raw data forms were regularly mailed to the research center where they were checked for completeness before entry into the computer. Data elements which were unclear or missing were verified by contacting the responsible counselor at the pretrial location. The availability of this complete and verified data base will greatly assist in this and in further research efforts.

The retrieval of criminal histories and their integration into the pretrial data base provided an opportunity to assess client recidivism for up to five years after program entry. Most evaluations of diversion programs have been able to follow participants for no more than two years. An important objective of this project was to assess the importance of some of the data elements on participant success or failure.

The data collection agreement was originally arranged to provide information to management and staff, as well as to state policymakers. Because the pretrial intervention program was phased out in 1986, no comprehensive report which included all of the data collection period was ever produced. This report, therefore, discusses aggregate data on client personal and legal characteristics, program conditions, compliance and disposition, and achievement of program goals.

The collection of this uniquely inclusive data base required the cooperation of all program sites in the state funded and operated pretrial program. It was possible only because the criminal justice system in Alaska is centralized at the state level.

Literature Review

Pretrial diversion programs, which have existed for more than two decades, have now proliferated to include a substantial number of jurisdictions. Programs exist for both adults and juveniles, for felons and misdemeanants, and for specific types of offenses and offenders.

Research on pretrial diversion has been less than thorough. Although the National Association of Pretrial Services Agencies (NAPSA, 1978) has attempted to encourage research and evaluation by establishing relevant standards and goals, few programs have satisfactorily collected evaluation data. Pryor (1982) surveyed 127 diversion programs and found that very few could provide appropriate or complete research data. Pryor and Smith, in a 1983 review of research findings on pretrial diversion, found a very small number of well-conceived and methodologically sound studies. Hillsman (1982) also criticized the quality of pretrial program evaluations. However, despite the inadequacy of some of the research, certain findings from the literature are relevant to a discussion of pretrial diversion in Alaska.

Early proponents of diversion foresaw benefits to offenders—minimum penetration into the system and a guarantee of dropped charges and a clean record—and benefits to the criminal justice system—cost savings, reductions in case loads for courts and corrections agencies. A decrease in criminal activity was promised as a benefit to the community as a whole. However, according to research evaluations of a number of pretrial diversion programs, most of these benefits have not been realized.

A substantial number of evaluations of both adult and juvenile programs have found that they widen the catchment net rather than minimize the extent of penetration into the justice system. In many instances the guarantee that charges

will be dropped after participation in the diversion program is offered primarily to persons in non-prosecutable cases, i.e., in cases where charges would be dropped even if the diversion program were not available. Where pretrial diversion programs result in net widening the cost of justice system processing is increased rather than decreased, and no relief is provided for strained resources at deeper penetration points (prosecution, sentencing, probation, incarceration).

A decrease in further criminal activity on the part of pretrial diversion clients was also expected by early advocates of diversion programs. Though recidivism reports are mixed and recidivism is measured in different ways, most evaluations suggest that recidivism rates are not significantly lower for pretrial diversion clients than for clients of other justice programs. This finding seems to hold regardless of type of program or type of client.

For juvenile clients recidivism results vary considerably. Studies of juvenile pretrial diversion programs have used both official records and self-reports of delinquency to measure recidivism. Although successful reductions in delinquent activity have been reported by Quay and Love (1977), Palmer and Lewis (1980) and others, some studies reported no impact on subsequent delinquency (Elliot et al., 1978; Haapanen and Rudisill, 1980; Quincy, 1981; Dunford et al., 1982), and one reported that juvenile diversion was associated with increased delinquent activity (Lincoln, 1976).

Evaluations of juvenile diversion programs repeatedly report net widening. Bohnstedt (1978) and Palmer (1979) concluded that substantial numbers of juvenile diversion clients received more processing than they would have if diversion programs had not been available. Such findings are contrary to the stated goals of most diversion programs, which are usually directed toward the least restrictive alternative. They should have as their clientele offenders who would have had more

serious dispositions rather than those who would have had none at all. Polk (1984) reviewed a number of studies which reported such "net widening." Blomberg (1980), Klien (1980), and Decker (1985) all reported results which indicated a widening of the net. This precludes assumptions of cost efficiency since more clients are added to the system than are removed from it. (While many researchers, using labeling theory, criticize net widening as a cause of increased delinquency, Binder and Geis (1984) view it as positive since services are extended to clients who would otherwise not receive them.)

Studies of adult pretrial diversion programs also frequently report net widening. Rovner-Piecznik (1974), comparing diverted clients to those in control groups, concluded that a substantial number of the diversion clients would not have been prosecuted even if diversion had not been an option. In a study of a Monroe County, New York diversion program Pryor et al. (1977) also used a comparison group to evaluate client outcomes. They concluded that one-third of the clients in the program would not have been prosecuted if the diversion program had not existed. They also found that pretrial clients made more court appearances than the control group, suggesting that the program did not relieve pressure on other parts of the system.

In a study of fifteen California programs, Agopian concluded that it "is difficult to escape the conclusion that [they] represent a very expensive alternative to formal processing," in part because they served a non-prosecutable clientele (1977:19). Hillsman reported that data from the Vera Institute's Court Employment Project "suggest that New York City prosecutors actively rejected from diversion eligible defendants who were 'convictable,' and screened into the program cases where there were technical problems or where the case. . . was too minor" (1982:382).

According to most studies, recidivism results for adults in pretrial programs were disappointing. For the most part recidivism rates were comparable to rates reported in studies of corrections releases. However, those studies which compared recidivism between client and control groups generally found that diverted clients were less likely to recidivate than control group offenders.

Lahners and McMasters (1981) compared recidivism rates among clients participating in a Lancaster County, Nebraska felony diversion program with a matched control group of eligible offenders processed the year before the program was initiated. Using a two year follow-up period he found that pretrial diversion clients had a lower rearrest rate (38.8%) than the control group (44.8%). The Pennsylvania Commission on Crime and Delinquency reported that first offenders in diversion programs were rearrested less frequently (10.2%) than those who had been incarcerated (20.8%) or those on probation (32.4%) (PCCD 1987).

Potter and Starnes (1981) found that in the Florida Treatment Alternatives to Street Crime (TASC) program substance abuse offenders who graduated as successes had the lowest rearrest rate of any comparison group during an 18-month follow-up period.

While rearrest appears to be the most widely used measure of recidivism in studies of adult repeat offenders, other definitions, such as reconviction or "recidivism by incarceration," are used (Hoffman and Stone-Meierhoefer, 1980; Illinois Criminal Justice Information Authority, 1987; and others). The pretrial diversion evaluations cited above primarily used rearrest as the criterion of recidivism, although some reported convictions as well.

Comparisons among recidivism studies are especially difficult because of the variation in the lengths of the follow-up periods. Recidivism studies have been reported where the follow-up period was six years (Hoffman and Stone-Meierhoefer,

1979 and Beck, 1987). These studies found that rates of rearrest were highest in the first two years after release, considerably lower during the second two years, and very low in succeeding years. Thus, a follow-up period of three to five years is probably adequate for most studies, while less than three years is probably not an adequate amount of time for an accurate assessment of recidivism rates. Because most of the pretrial programs cited measured recidivism after a follow-up period of less than two years, it is difficult to make comparisons among the studies or to use them as a base for assessing the Alaska program.

Additional constraints involved in comparing diversion studies include defining clients as felons or misdemeanants and comparing demographically different clients. State penal codes differ considerably in defining felonies, and, within states, local attitudes and policies may determine how clients are selected for participation in a diversion program. All of the studies cited above have involved specific local jurisdictions with their own peculiar demographic characteristics.

Because Alaska has a highly centralized criminal justice system, its pretrial intervention program was operated on a statewide basis by a state agency under state guidelines. Therefore the available data permit a study of different sites operating under the same guidelines and facilitate an analysis of the ways in which prosecutors and program staff adapted statewide policies to meet widely varying local conditions.

Background of the Study

A. The Alaska Justice System

Alaska, the largest of the fifty states, with 570,833 square miles, has a population of only 547,600. Over sixty per cent of the population reside in the three

major urban areas of Anchorage, Fairbanks and Juneau (Alaska Department of Labor, 1985). The remaining number live in one of the smaller communities scattered across the state. In order to serve the needs of a small, broadly distributed population governmental services have been highly centralized. This centralization was a factor in the establishment of a comprehensive pretrial diversion program and facilitated the collection of a complete data base.

The Alaska State Constitution vests considerable authority in the executive branch, within which are three departments with responsibility for the justice process: Public Safety, Corrections, and Law.

The Department of Public Safety, headed by a commissioner appointed by the governor, is the primary law enforcement agency in Alaska. It enforces state criminal, traffic, fish and game and fire safety laws. Located within the Department of Public Safety are the Office of the Commissioner, Division of Administrative Services, Division of Fire Prevention, Division of Fish and Wildlife Protection, Division of Alaska State Troopers, Division of Motor Vehicles, the Highway Safety Planning Agency, the Alaska Police Standards Council, the Violent Crime Compensation Board, the Council on Domestic Violence and Sexual Assault and the Public Safety Academy.

The Alaska State Troopers bear responsibility for law enforcement in all areas where no municipal police agencies function. Trooper detachments are deployed throughout six regions across the state. Since individual troopers can hold responsibility for immense geographical areas, in many of the small, widely-scattered, Native villages a locally-based Village Public Safety Officer (VPSO) assists the assigned trooper in the maintenance of order and the enforcement of state laws.

The Department of Corrections, also under a commissioner appointed by the governor, operates thirteen facilities, both pretrial and post-conviction, throughout the state; in addition, the department is responsible for probation and parole services. While contract facilities for corrections exist, there are no city, county or federal prisons in the state.

The Department of Law, headed by the Attorney General, is responsible for prosecuting violations of state laws and providing legal services to state executive agencies. The department has three major components: the Administrative Services Division, the Civil Division and the Criminal Division. The Civil Division provides legal aid to executive agencies, handles general litigation issues involving the state and administers the drafting and review of legislation and regulation and provides consumer protection services. The Criminal Division provides legal services for the state's criminal justice system and prosecutes violations of state criminal law in Alaska's state courts through thirteen regional district attorney offices.

The Alaska court system is unified and state funded. There are four levels of court jurisdiction, each with different powers and responsibilities. These four levels include the supreme court and superior courts, both established by the Alaska State Constitution; district courts, established in 1959; and a court of appeals, established in 1980. The state is divided into four judicial districts with fifteen superior/district court locations and forty-four locations for district courts only. District courts are headed by either judges or magistrates. (See map.)

Because of the centralized structure of the Alaska courts, the Alaska Department of Law prosecutes cases which in other states might be handled in a local county or borough court. Thus, the department is a comprehensive source of data on all prosecutions under state law. In Alaska the Pretrial Intervention

project was established under this department because both the diversion decision and the ultimate disposition are prosecutorial responsibilities.

B. A Brief History of Pretrial Diversion in Alaska

In 1978, with funds provided in part by the Law Enforcement Assistance Administration, the Alaska Department of Law initiated a pilot Pretrial Intervention (PTI) program in Anchorage. Anchorage, as the state's largest urban center with the largest prosecutor's office, was the logical site for the initial development of the program. The program was intended to provide an alternative to full prosecution in cases where the offense behavior did not appear to warrant it. The objectives of the program were: (1) to provide prosecuting attorneys with a viable alternative to formal processing with defined criteria and guidelines; (2) to provide rehabilitative services to Alaska residents charged with essentially non-serious first offenses; and (3) to provide restitution either to the victim through reimbursement for monetary damages or to society through community service.

Both state and municipal prosecutors made referrals to the program. Screening was required by the prosecuting attorney in order to assure that evidence was adequate in each case for a conviction. Program guidelines stipulated that non-prosecutable cases should not be referred to the program.

To be eligible for program referral the defendant must be charged as an adult with a single offense and must be a first offender charged with a property crime in which no one was endangered, assaultive behavior in a family setting or possession, sales or distribution of a small quantity of a controlled substance. He could be charged as either a misdemeanor or a felon though the intake process was different in felony and misdemeanor cases (See Appendix 1). Exceptions to the first offender criteria included: a prior conviction under state motor vehicle codes or fish and game

regulations; a prior domestic violence charge if the instant offense was of the same nature; or a prior conviction the nature of which was such that the behavior could not be considered habitual (e.g., it occurred several years previous to the instant offense).

After referral offenders were interviewed and given the option of participating in the program or continuing with prosecution. The defendant must volunteer for participation and express his willingness to enter into a performance contract detailing requirements for successful termination. Successful completion of the program resulted in a recommendation that the criminal charges be dismissed under Rule 43(a) of the Rules of Criminal Procedure.

An evaluation of the first year of program operation, which was conducted by the Justice Center at the University of Alaska, Anchorage, as well as an assessment and favorable recommendation made by the Alaska Judicial Council, led the state legislature to fund a statewide pretrial intervention program in FY 1981.

The program expanded to Barrow, Bethel, Fairbanks, Juneau, Kenai, Nome and Valdez. In 1982, Ketchikan, Kodiak and Sitka began providing PTI services, and Dillingham and Palmer joined the program in 1983.

The Pretrial Intervention Program received referrals of accused felons and misdemeanants charged with property crimes or misdemeanor personal crimes. The PTI program developed special means of handling domestic assault cases and petty shoplifting cases, which constituted a substantial number of referrals. The PTI staff consulted with victims, and preferences for prosecution over restitution or community work service were then relayed to the prosecutor, who made the final decision (Partch et al., 1984).

At intake PTI counselors identified individual problems and needs and completed admission forms which included legal and personal characteristics. In

consultation with the client the counselor completed a performance agreement form which stipulated the conditions for deferred prosecution and specified program conditions: community service, restitution, participation in counseling programs, etc.

An evaluation component was built into the Pretrial Intervention Program by the Department of Law in order to assure that the program was operating in the best interest of the community, the victim and the defendant. From the beginning the evaluation effort involved the Justice Center at the University of Alaska Anchorage.

Because of a statewide economic depression the Alaska Department of Law Pretrial Intervention Program was ended in 1986. While prosecutorial diversion continues to be a possibility in some jurisdictions, responsibility for both intake and provision of services to program participants now varies throughout the state. The Division of Probation of the Alaska Department of Corrections has assumed responsibility for a reduced program in Anchorage. In other jurisdictions diversion is no longer a prosecutorial option.

C. The Role of the Justice Center – History

The Justice Center is a research institute within the University of Alaska Anchorage. It has responsibility for investigation into the areas of crime, law, law enforcement and the administration of both civil and criminal justice. The Center has been involved in the Pretrial Intervention Program since its inception.

The overall evaluation component for the program involved two phases, both of which were handled by the Justice Center. The first phase, focusing on the Anchorage pilot program, identified the types of information to be included on the data collection forms and formulated the processes and procedures necessary for the

generation of program evaluation information. Thus the first phase served as a "pretest" for the actual evaluation, which began after the first twelve months of program operation.

In 1982, following the expansion of the program, arrangements were made between the Alaska Department of Law and the Justice Center for continuous evaluation, data collection, storage, and processing. This second phase of the evaluation plan responded to the desires of both the Alaska Legislature and the Department of Law for collection of information to be used for policy decisions. The Justice Center staff and staff from the pretrial program collaborated on the development of an evaluation which would provide information for multiple audiences. Center staff provided professional and technical expertise regarding program development and evaluation; PTI staff provided expertise in those substantive areas of law and the Alaska legal system which related to diversion.

Workshops with PTI staff were held in which data analysis concepts were introduced, the importance of accurate data was stressed, and appropriate data and data collection procedures were discussed. With the cooperation and assistance of PTI staff, the Justice Center examined the relevance of data which had been recorded, established new data requirements, and constructed standardized data collection forms, which were put into use in 1983. The forms were completed by PTI counselors at all sites and mailed to the Justice Center for storage and processing. Additional workshops were conducted on form completion and the uses to which the aggregate data would be put.

Because regular use and processing of the first standardized forms identified data problems, the forms were revised in 1984 to provide additional information and to make them easier to complete. Justice Center staff received and entered data

collection forms from 1983 until 1986, when the Department of Law began to terminate the program.

As a result of its involvement throughout the life of the pretrial program, the Justice Center has accumulated a uniquely complete computerized data base containing extensive program information on every pretrial diversion client in the state between 1983 and 1986. The data were used to provide annual aggregate information for the use of the Department of Law, but no extensive analysis of the full data set has ever been completed.

When the Justice Center incorporated the Statistical Analysis Unit for the state in 1986, it identified the pretrial data base as a priority for analysis. The projected analysis would necessitate the preparation of a merged data file, data entry of cases accumulated during the final stages of the program, and the acquisition of criminal history records from the Department of Public Safety for recidivism evidence.

Research Methodology

The pretrial data base was collected over a four-year period (1983 to 1986) from specially designed self-duplicating admission and release forms. (See Appendix B). The duplicated page was designed to obliterate personal identifiers (name, address, etc.) and provide only codable data for the project. When the client completed (or was terminated from) the program, the completed admission and release copies were mailed to the Justice Center where they were checked for legibility and completeness. Questions were resolved through telephone contact with the PTI location and the raw data were then entered into the university computer.

In 1984 the forms were evaluated and revised by PTI and Justice Center staff. A different code book was required for the new forms. During the transition between old and new forms release information was completed on new release forms for clients who had been admitted under old admission forms. Data entry was continued in three different computer files: old admission/old release, old admission/new release, and new admission/new release. As part of the current project programs were developed to merge the three files into a master data set with a single code book.

The admission data included legal, personal and treatment requirement information for all clients. The legal data included the instant offense, type of offense, prior record, type of attorney, type of victim, jurisdiction, etc. Personal information included such demographic data as age, sex, race, marital status, length of residence, education and employment histories, as well as information gleaned from the intake interview: whether the client had been a victim of physical or sexual abuse, if he had problems with alcohol or drugs, if he had attempted suicide, etc. Elements of the treatment plan were also included on the admission form: amount of monetary restitution owed, number of hours of community service required,

designation of a counseling program, requirements to attend school, seek or maintain employment, and requirements to remain in contact with the PTI counselor.

The release forms addressed the extent to which the client had complied with the requirements of his or her treatment plan: restitution dollars paid, service performed, completion of counseling program, etc. The release form included final disposition of the client – satisfactory or unsatisfactory compliance with the program contract – as well as any charge filed against clients arrested while participating in the program.

The addition of criminal histories to the data base was accomplished with the cooperation and assistance of the Alaska Department of Public Safety. Department of Public Safety crime files were searched for arrest data for all PTI clients. Care was taken in matching criminal histories to clients in the original data file to conform to the privacy guidelines specified in Alaska Administrative Code 6.60.090, "Research Use of Criminal Justice Information." The criminal histories returned were complete, i.e., they included the pretrial intake offense as well as any previous arrests. Arrest charge, arrest date, conviction charge and conviction date were included as was a total count of all arrests for each client. Recidivism in this study was defined as an arrest on a date subsequent to the client's intake date; thus clients could be counted as recidivists whether they reoffended while still in the PTI program or after termination from the program. While the PTI admission forms indicated an Alaska statute as the instant offense, the data retrieved from the Department of Public Safety were expressed as an NCIC offense code. PTI admission data were recoded to conform to the NCIC criminal history data.

FIGURE I

ANNUAL PRETRIAL INTAKES

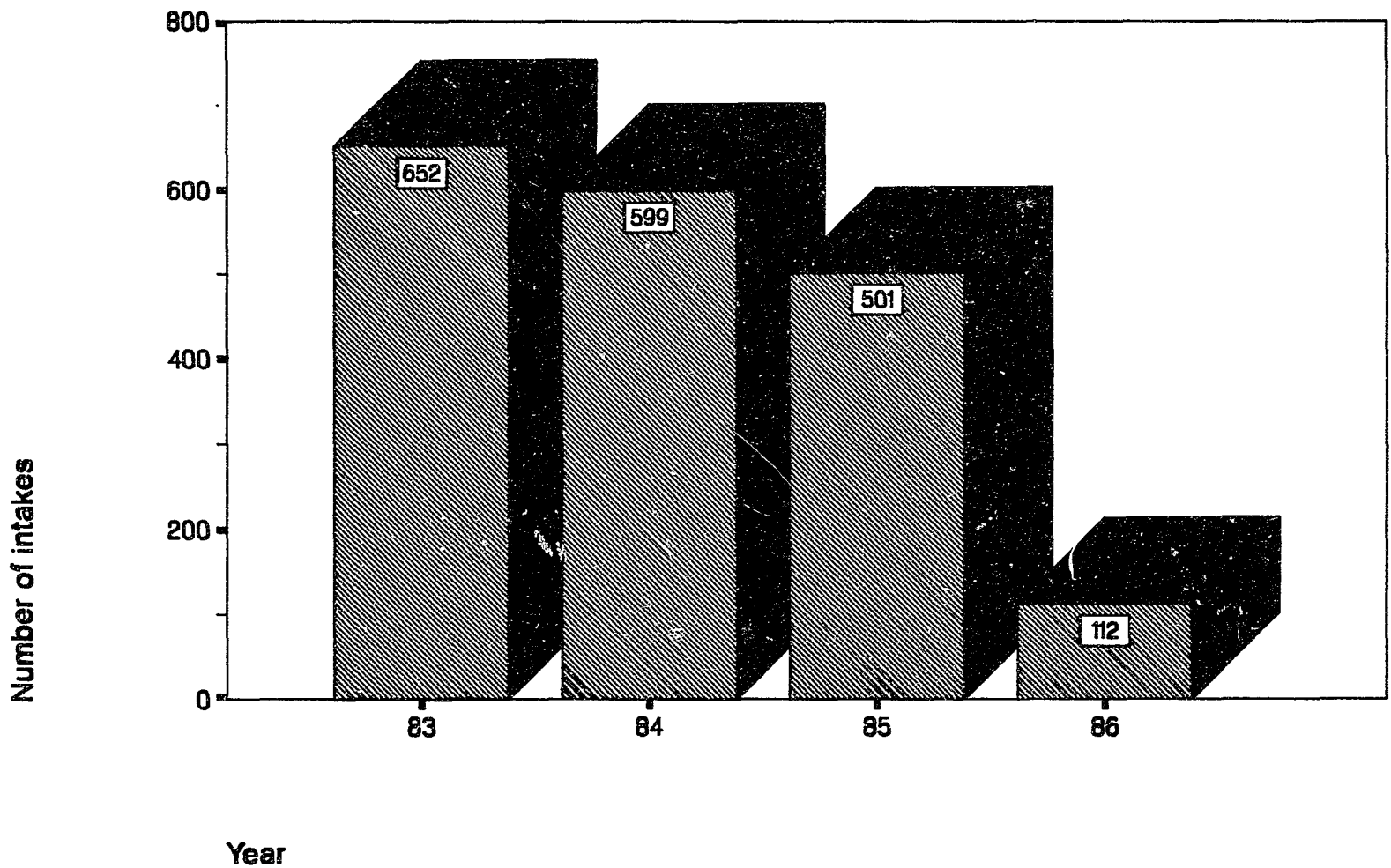

Research Results

The data collection agreement between the Justice Center and the Alaska Department of Law was designed to provide information to PTI employees and managers as well as state policymakers. Analysis of the data from the program operation period provides an opportunity to describe participant clients, assess intake policies and report program requirements and program accomplishments.

The data set compiled by the Justice Center between 1983 and 1987 contained 1864 complete cases. Figure I describes these by intake year: 652 clients entered the program in 1983, 599 in 1984, 501 in 1985 and 112 in 1986. The low number of intakes in 1986 is due to a decision to reduce/eliminate state funding for the program. These clients were included in the aggregate descriptive analyses but were excluded from some of the detailed analysis and from the recidivism assessment because of the short follow-up period.

A. Personal and Social Characteristics

The study looked at a variety of personal and social characteristics of PTI clients which are listed in Figure II, Client Profiles. Alaska PTI clients were overwhelmingly young, male and Caucasian. To a large extent this is true of the entire Alaska population, in which the median age is 26.6, compared to 31.5 for the United States. Men constitute 51.4 per cent of Alaska residents and whites 77.1 per cent (Alaska Department of Labor, 1985).

While the ages of PTI clients ranged from 17 to 66, the vast majority were young. Their average age was 26; their median age, 23. More than a third (36.3%) were under 21; nearly three-fourths (73.2%) were under 30. Since underage drinking is, in effect, a status offense which can only be committed by persons under age 21, the 204 clients charged with violation of this statute have had some impact

on the age distribution. They account for 30.1 per cent of the 677 PTI clients under age 21 and, if eliminated from the sample, would reduce the percentage of clients in this age group from 36.3 per cent to 25.2 per cent.

Male clients constituted 75.2 per cent of pretrial participants (N=1402) and female clients 24.8 per cent (N=463). Women account for 21.2 per cent of all arrests nationally and 20.8 per cent of all arrests in Alaska. Therefore, their representation in the pretrial sample is not proportionally unexpected.

Nearly 29 per cent of the participants were married at program intake, 54.9 per cent had never been married, and the remainder were widowed (1.0%), divorced (12.3%), or separated (2.8%). Given the youthfulness of the PTI clients, these figures on marital status are expected.

A substantial portion of PTI clients were long-term Alaska residents. The average number of years in residence was 13.8; the median 12.0. Since the years of data col-

FIGURE II. Client Profiles

| | | | |
|--|----------|-------|----------|
| Age | | | |
| Mean | | 26.05 | |
| Median | | 23.0 | |
| Range | | 17-66 | |
| | # | | % |
| Sex | | | |
| Male | 1402 | | 75.2 |
| Female | 463 | | 24.8 |
| Total | 1865 | | 100.0 |
| Race | | | |
| White | 1297 | | 69.5 |
| Black | 94 | | 5.0 |
| Native | 398 | | 21.3 |
| Other | 76 | | 4.1 |
| Total | 1865 | | 99.9 |
| Marital Status | | | |
| Single | 1024 | | 54.9 |
| Married | 538 | | 28.8 |
| Divorced | 230 | | 12.3 |
| Separated | 52 | | 2.8 |
| Widowed | 19 | | 1.0 |
| Unknown | 2 | | .2 |
| Total | 1865 | | 100.0 |
| Education | | | |
| No High School | 468 | | 25.1 |
| GED | 224 | | 12.0 |
| H S Diploma | 719 | | 38.6 |
| Some College | 345 | | 18.5 |
| AA Degree | 43 | | 2.3 |
| BA Degree | 32 | | 1.7 |
| Graduate work | 34 | | 1.9 |
| Total | 1865 | | 100.1 |
| Employment | | | |
| Full-time | 763 | | 40.9 |
| Part-time | 257 | | 13.8 |
| Unemployed | 595 | | 31.8 |
| Other (student homemaker, retired, etc.) | 250 | | 13.5 |
| Total | 1865 | | 100.0 |
| Offense Type | | | |
| Felony | 688 | | 36.9 |
| Misdemeanor | 1177 | | 63.1 |
| Total | 1865 | | 100.0 |
| Type of Attorney | | | |
| None | 517 | | 27.7 |
| Private | 463 | | 24.8 |
| Public defender | 767 | | 41.1 |
| Court appointed | 114 | | 6.1 |
| Unknown | 4 | | .3 |
| Total | 1865 | | 100.0 |

lection coincided with a period which brought a large influx of newcomers to the state as well as the beginning of a period of economic decline, data on years in Alaska deserve a closer look. If PTI services were extended primarily to newcomers or temporary workers attracted by the economic boom, the need for such a program would decline with the economy. In fact, more than a quarter of the sample had lived in Alaska for no more than four years at intake (N = 514) but only 6.5% had lived in Alaska for one year or less. The program then provided alternative sentencing options to long-term Alaska residents, not just to transient or temporary workers. This finding suggests that there is a continuing need for such dispositions.

The racial/ethnic mix of pretrial clients does not appear to be as reflective of the Alaska population as age is. According to the 1980 U.S. Census, 77.1 per cent of the Alaska population was Caucasian, 16.0 per cent Alaska Native, 3.32 per cent Black and 3.57 per cent other. The PTI population was 69.5 per cent white, 21.3 per cent Alaska Native, 5.0 per cent Black and 4.1 per cent other. Racial minorities are overrepresented in the sample when compared to their proportions in the population as a whole, but minorities constitute an even greater proportion of the Alaska jail and prison population: Alaska Natives constitute 34 per cent of inmates and Blacks, 9 per cent (Department of Corrections, 1985). These numbers lead to the conclusion that their representation in the PTI sample should not be construed as evidence of discrimination but as an indication that diversion provided an alternative to further processing for all ethnic groups. In 1980 the Alaska Commission on Minority Sentencing recommended increased use of pretrial diversion for minorities in order to reduce discrimination in sentencing (Alaska Legislature, 1980). The representation of minorities in the PTI sample may be considered evidence that the PTI program fulfilled the Commission's expectation.

Figure III. Racial/Ethnic Distribution by PTI Location

| | | Race as a Percentage of Pretrial Population | | | | Race as a Percentage of General Population | | | |
|-----------|-----|---|-------|--------|-------|--|-------|--------|-------|
| AREA | (N) | White | Black | Native | Other | White | Black | Native | Other |
| Anchorage | 365 | 73.6 | 12.5 | 9.5 | 4.4 | 85.86 | 5.38 | 5.17 | 3.59 |
| Barrow | 15 | 7.1 | 7.1 | 78.6 | 7.1 | 21.81 | .33 | 76.8 | 1.06 |
| Bethel | 40 | 10.0 | - | 82.5 | 7.5 | 14.56 | .47 | 84.31 | .66 |
| Fairbanks | 619 | 74.4 | 5.5 | 16.0 | 4.0 | 85.81 | 5.63 | 5.61 | 2.95 |
| Juneau | 265 | 72.7 | 1.5 | 21.0 | 4.9 | 85.51 | .42 | 11.21 | 2.86 |
| Kenai | 114 | 92.1 | 1.8 | 5.3 | .9 | 91.69 | .37 | 6.73 | 1.21 |
| Ketchikan | 65 | 76.6 | - | 20.3 | 3.1 | 84.62 | .25 | 12.42 | 2.71 |
| Kodiak | 101 | 73.3 | - | 17.8 | 8.9 | 71.54 | .9 | 10.96 | 8.6 |
| Kotzebue | 43 | 2.3 | - | 97.7 | - | 23.11 | - | 76.6 | .39 |
| Nome | 84 | 17.9 | 1.2 | 78.6 | 2.4 | 19.98 | .24 | 79.38 | .4 |
| Palmer | 122 | 88.5 | 4.1 | 5.7 | 1.6 | 94.7 | .29 | 4.22 | .79 |
| Sitka | 19 | 40.0 | - | 55.0 | 5.0 | 74.79 | .38 | 21.39 | 3.44 |
| Valdez | 13 | 69.2 | 7.7 | 23.1 | - | 84.94 | .44 | 12.7 | .44 |

However, the racial mix of pretrial clients varies by location as does the racial mix of the general population. Figure III compares race by PTI location for both pretrial clients and the Alaska population. In all but 2 of the 9 PTI locations where the white population is dominant, the proportion of minorities in the PTI population is greater than the proportion in the general population, sometimes overwhelmingly so. The small number of cases at some PTI locations reduces the significance of the differentials in racial proportions, but in communities where Alaska Natives are in the majority, the proportion of whites in the pretrial program is considerably smaller than the proportion of whites in the general population. All in all, the data show that the PTI program met the needs of different geographic areas and served the Alaska Native community well.

One social factor of particular interest in the state is alcohol abuse which is frequently cited by newspapers and legislators as a major problem in Alaska. Three intake items addressed this problem: Was the client under the influence at the time of the offense? Had the client a history of problems with alcohol? Had the client previously attended an alcohol treatment program? A substantial portion of clients (35.7%) had been drinking when their offense was committed (N=665) and an additional 73 were under the influence of both alcohol and drugs. Nearly as many, 626, had a previously identified alcohol problem (33.6%) but many fewer (N=292) had been in an alcohol treatment program (17.6%); of these 107 (5.7%) were in a program at intake, 149 (8.0%) had completed a program, and 36 (1.9%) had begun a program but had left it before completion. Identification of alcohol problems at admission was important to PTI counselors in developing treatment plans for clients.

B. Legal Variables

Portions of the aggregate data can be used to examine intake policies and program practices. Net widening has been widely reported in the pretrial evaluation literature. In many cases diversion was used for persons who would not have been prosecuted, thus increasing rather than decreasing the number of persons in the system. The Alaska program specifically prohibited the use of pretrial intervention for non-prosecutable offenses: "The diversion program may not and will not be utilized as a mechanism to compromise or dispose of (inadequate) cases" (Cobb, 1981). Thus net widening should not be found in our assessment of the Alaska Pretrial Intervention program. This phenomenon is best measured through the use of a comparison sample, but this was not possible in the current study. However, type of crime, type of attorney, prior record, and intake offense can be used to provide some indication of the extent to which the program did or did not widen the net. (See Figures II and IV.)

Although intake guidelines permitted referral of felons and of defendants with prior records, the program was primarily intended for people charged with nonserious first offenses. The fact that more than a third of the sample (36.8%) were charged as felons suggests that the PTI program did serve as an alternative to more severe sanctions. Because diversion is a desirable alternative to either probation or incarceration, it might be part of a charge negotiation between prosecutor and defense counsel in those situations in which defense is interested in a low risk disposition and the prosecutor in rapid disposition of a weak case. That diversion was offered to 517 non-represented PTI clients further suggests that the program did not result in net widening. In addition, more than a third of the clients in our sample (36.3%) were not first offenders, an even stronger indication that the PTI program did not result in a widening of the net. (For one charge, however - that of minor

consuming – there is some evidence of net widening and this will be discussed below.) These broad data categories strongly suggest that diversion in Alaska was an alternative to more severe sanctions and did minimize penetration into the criminal justice system.

Figure IV. Frequency of Intake Offense Categories

| Rank | Offense | Number | Percent | Cumulative Percent |
|------|---|-------------|--------------|--------------------|
| 1. | theft | 530 | 28.4 | 28.4 |
| 2. | drug | 227 | 12.2 | 40.6 |
| 3. | burglary/trespass | 206 | 11.0 | 51.6 |
| 4. | assault | 205 | 11.0 | 62.6 |
| 5. | minor consuming | 204 | 10.9 | 73.5 |
| 6. | criminal mischief | 141 | 7.6 | 81.1 |
| 7. | forgery (check/credit card) | 77 | 4.1 | 85.2 |
| 8. | weapons misconduct | 49 | 2.6 | 87.8 |
| 9. | disorderly conduct | 33 | 1.8 | 89.6 |
| 10. | fraud | 31 | 1.7 | 91.3 |
| 11. | contributing to delinquency of minor | 29 | 1.6 | 92.9 |
| 12. | perjury/false swearing | 25 | 1.3 | 94.2 |
| | others | 108 | 5.8 | 100.0 |
| | TOTAL | <u>1865</u> | <u>100.0</u> | <u>100.0</u> |

Intake offense categories are listed in Figure IV, Frequency of Intake Offense Categories. Offenses were consolidated to simplify reporting. The most common intake offense, theft, included theft in the 2nd degree, a Class C felony (225 cases);

theft in the 3rd degree, a Class A misdemeanor (234 cases); and concealment of merchandise, an offense specifically related to shoplifting (70 cases), although the other theft offenses also include shoplifting. A single instance of theft by deception has also been placed in this category. The difference in degree is related to the value of the goods stolen. No other intake offense approaches the number of thefts, which constituted 28.4 per cent of all PTI offenses.

Drug-related offenses included 157 felony offenses, 33 in the 3rd degree and 124 in the 4th degree. The 3rd degree charge involves manufacture and/or delivery to underage persons and/or possession on school grounds by someone 18 or older. It is a Class B felony subject to imprisonment for up to 10 years. A felony drug charge in the 4th degree may include manufacture, delivery, fraudulent obtainment or possession, and the penalty may be up to 5 years imprisonment. The remainder of the drug charges were Class B misdemeanors with penalties of up to 90 days; 68 of these were 6th degree offenses primarily tied to possession of specific substances, and 2 were charges of manufacture or delivery of an imitation controlled substance.

Burglary/trespass, assault, and minor consuming were the only other offenses which appeared in the offense data more than 200 times. Included were 15 counts of burglary in the first degree, a Class B felony; 112 counts of burglary in the second degree, a Class C felony; and 79 counts of criminal trespass, a Class B misdemeanor. Assault included 1 count of 1st degree assault, 2 counts of 2nd degree, 16 counts of 3rd degree and 186 counts of 4th degree assault. Assault in the first degree is a Class A felony; assault in the 4th degree is a Class A misdemeanor. Charges resulting from domestic violence incidents are often classed as 4th degree assaults; the PTI program established domestic violence as a special concern.

The crime of minor consuming has been a Class A misdemeanor in Alaska since the drinking age was raised from 19 to 21 in 1983. Since young people often

experiment with alcohol, this behavior is treated very leniently in most jurisdictions – often with a warning or with a summons to appear, with charges dropped upon appearance. The appearance of this offense among the top five in the data set suggests that PTI intake policies may have resulted in net widening for at least this charge. However, it should be noted that the Alaska PTI program was in existence during the transition in the drinking age law and some officials in some jurisdictions had difficulty deciding how to handle this relatively new offense. Nearly 90 per cent of the PTI clients charged with minor consuming were located in Fairbanks (N = 180) where college students in the vulnerable age bracket constitute more than 6 per cent of the area population. The remaining 24 minor consuming offenses were scattered through eight PTI sites and constituted a very small proportion of the total number of offenses. If such an offense is tied to net widening it can be construed as such at only one Alaska PTI site, thus serving to illustrate the point that pretrial decisions are often colored by local concerns and policies.

These first five offense categories are the only ones to include 200 offenses. Together the offenses related to theft, drugs, burglary, assault and minor consuming account for nearly 75 per cent of all PTI intake offenses. The clear majority of offenses are crimes against property or crimes against the public order. Except for minor consuming, each of these fits the specific eligibility criteria. Assault is the only crime against persons included among the 1865 intake offenses; it was usually a domestic violence charge specifically addressed in the program guidelines. Within the "other" category are ten unspecified municipal misdemeanors and a variety of offenses which appear from one to thirteen times, including three counts of littering, five violations of the traffic code, thirteen counts of promoting contraband, five counts of hindering prosecution, etc. Because there is a wide range in the type as well as in the degree of seriousness of these offenses, they do not assist in any

determination of the extent to which PTI constituted either an alternative to full processing or a widening of the net. Jurisdictional differences in intake policies can be seen in the minor consuming example above, and it may be that different prosecutor's offices viewed the program as serving different purposes.

Figure V. Type of Offender by Time Served in Program

| Time Served | Misdemeanant | | Felon | |
|---------------------|--------------|------|-------|------|
| | # | % | # | % |
| 0 - 3 months | 74 | 6.3 | 38 | 5.5 |
| 3 - 6 months | 833 | 79.8 | 74 | 10.8 |
| 6 - 9 months | 143 | 12.2 | 59 | 8.6 |
| 9 - 12 months | 88 | 7.5 | 393 | 57.3 |
| more than 12 months | 38 | 3.2 | 122 | 17.8 |

Another policy made clear from the data is broad agreement about the length of time offenders should remain under PTI contract. Program guidelines did not place requirements on the length of the PTI contracts, but the data suggest substantial agreement about the duration of participation for different types of offenders. The contract which stipulates length is signed by both prosecutors and program staff. Although the number of weeks in the program ranged from 1 to 151 (nearly 3 years) 55.75 per cent of the clients spent either 6 months (26 weeks) or 1 year (52 weeks) under contract. The bulk of those assigned to 26 weeks were misdemeanants; the bulk of those assigned to 52 weeks were felons. Figure V provides a visual illustration of offense level by length of contract expressed in 3 month increments.

While there is overlap, a policy of assigning felony offenders to one year or more and misdemeanor offenders to 6 months or less is evident from this figure: 77.1 percent of the misdemeanants served a maximum of 6 months, while 75.1 per cent of the felons served at least 9 months.

C. Program Operation

The 1864 PTI participants served an average of 9 months under a PTI contract in 13 locations throughout the state. Altogether they paid a total of \$435,081 in monetary restitution and performed 65,302 hours of community service.

Fairbanks made greater use of pretrial diversion than any other PTI location. Although the general population of the Fairbanks area (45,000) is considerably smaller than that of Anchorage (225,000) the number of PTI clients in Fairbanks (N=618) was 41 per cent greater than the number in Anchorage (N=367). When 122 clients in Palmer, which is in the Anchorage Bowl area, are added to the Anchorage base there are still fewer cases than in Fairbanks. Clearly pretrial intervention was a disposition that was enthusiastically received by one PTI location. Since we have noted that the use of diversion may vary according to local issues and concerns, the data from Fairbanks can be used to assess such differences.

It was noted above that almost 90 per cent of all pretrial clients who had been charged with minor consuming were in the Fairbanks sample, demonstrating a local perspective on underage drinking. If the 180 cases were eliminated from the Fairbanks sample the PTI population would still be numerically larger than that in Anchorage and almost as large as Anchorage and Palmer combined. When they are included they constitute the largest offense category at that site (29.3% of all offenses). These underage drinkers affect the age distribution in Fairbanks. While offenders under 21 constituted 36.3 per cent of the total sample, they were 49.8 per

cent of the Fairbanks sample. Without them the youthful offenders would be only 21 per cent of the Fairbanks clients.

Since Fairbanks has a residential college campus and underage drinkers are likely to have been from the college student population, the Fairbanks sample was expected to be better educated than the total sample but this did not prove true: 24.3 per cent of Fairbanks clients had no high school diploma compared with 24.9 per cent of the total sample.

Only 30.7 per cent of the clients were required to pay restitution (N = 574). The total amount required (\$665,785) was considerably more than the amount that was actually paid. In general, clients owed fairly small amounts; 24.2 per cent owed no more than \$100; 57.3 per cent owed \$500 or less; and 72.5 per cent, \$1,000 or less. Only 26 clients, 4.6 per cent of those required to make restitution, were ordered to pay \$5,000 or more. The amounts owed ranged from \$1 to \$50,000.

Eighty-eight clients paid none of the restitution they owed, the remainder made at least partial payments. For many a good faith effort to pay permitted termination from the program with favorable dispositions. Many clients were not employed during their contract periods and some were not expected to pay the full amount owed before termination from the program. As part of their PTI contract, 293 clients were expected to seek employment during their program participation.

Community service was required of more PTI clients than was monetary restitution. Eighty per cent (N = 1493) were assigned such work while only 30.7 per cent were required to pay restitution. At admission these 1493 offenders were assigned to do a total of 86,313 hours of community work. Their release forms, however, show that they performed somewhat fewer hours (65,302). Since much of the service to which offenders were assigned was performed in groups under staff supervision there were limits to the number of hours which could be completed.

Community service was waived for 124 clients; most of the remainder performed a bit less than had originally been expected of them.

At intake PTI counselors assess client histories and problems and refer those in need of special treatment to a number of different treatment programs including alcohol counseling, psychological counseling and even career counseling. Figure VI lists the treatment program and the outcome of client participation in it. Generally the success rate (program completion) is approximately 60 per cent and the failure rate (no participation) approximately 20 per cent regardless of type of treatment program. Not surprisingly, substance abuse programs were required of the largest number of PTI clients, with 624 referred for alcohol treatment and 209 for drug treatment. Of offenders in alcohol counseling programs, 65 per cent (N=406) successfully completed the program and 16 per cent (N=104) failed to participate. The remainder (19%) were in partial compliance with this PTI condition. The success rate for those in drug counseling programs was 59 per cent and the failure rate, 20 per cent.

Figure VI. Client Participation in Treatment Programs

| Type of Treatment | # of Clients Assigned | Completion | | Partial Completion | | No Participation | |
|---------------------------------------|-----------------------|------------|------|--------------------|------|------------------|------|
| | | # | % | # | % | # | % |
| Alcohol Counseling | 624 | 406 | 65.0 | 114 | 18.3 | 104 | 16.7 |
| Drug Counseling | 209 | 123 | 58.9 | 44 | 21.0 | 42 | 20.1 |
| Domestic Violence Counseling | 163 | 98 | 60.1 | 39 | 23.9 | 26 | 15.9 |
| Psychological Counseling (individual) | 156 | 101 | 64.7 | 35 | 22.4 | 20 | 12.8 |
| Psychological Counseling (group) | 56 | 34 | 60.7 | 12 | 21.4 | 10 | 17.8 |
| Career Counseling | 25 | 6 | 24.0 | 8 | 32.0 | 11 | 44.0 |

Recidivism in the PTI Sample

There were no surprises in the recidivism data from the Alaska PTI project. In general, PTI participants were rearrested at rates similar to those reported in other pretrial diversion evaluation projects and to those reported in studies of other kinds of programs, including prison release. While offenders released from prison are more likely to be arrested or reincarcerated (on a new charge or on a parole violation), Wallerstedt (1984) reported general recidivism rates of 24.1 to 40.0 in 14 states with close to one-third of all released prisoners reincarcerated three years after release. Overall, approximately one-third of Alaska PTI clients were rearrested after their program intake date.

Criminal histories of all pretrial clients were retrieved from the Alaska Department of Public Safety and added to the data base in November, 1987. The criminal histories were complete and included the PTI intake offense as well as previous arrests. Dates of arrest were included in the criminal history file and failure was determined by counting only those arrests with dates later than the PTI intake date.

Approximately 33 per cent of the total sample of 1964 were rearrested after their intake date. Because the follow-up period for clients who entered the program in 1986 was less than two years these cases were excluded from the rearrest analysis. The final recidivism sample totaled 1,753 clients who entered the program in 1983, 1984, or 1985, thus providing follow-up for two to four-and-one-half years. Of the 1,753 cases, 574 (32.7%) were rearrested after they were admitted into the program and were categorized as program failures. (See Figure VII Rearrest by Year.)

The recidivism literature reports that the failure of prison releases is most likely to occur within the first two years of release, with successively smaller rearrest rates in succeeding years up to six (Hoffman & Stone-Meierhoefer, 1979).

FIGURE VII

RECIDIVISM BY YEAR

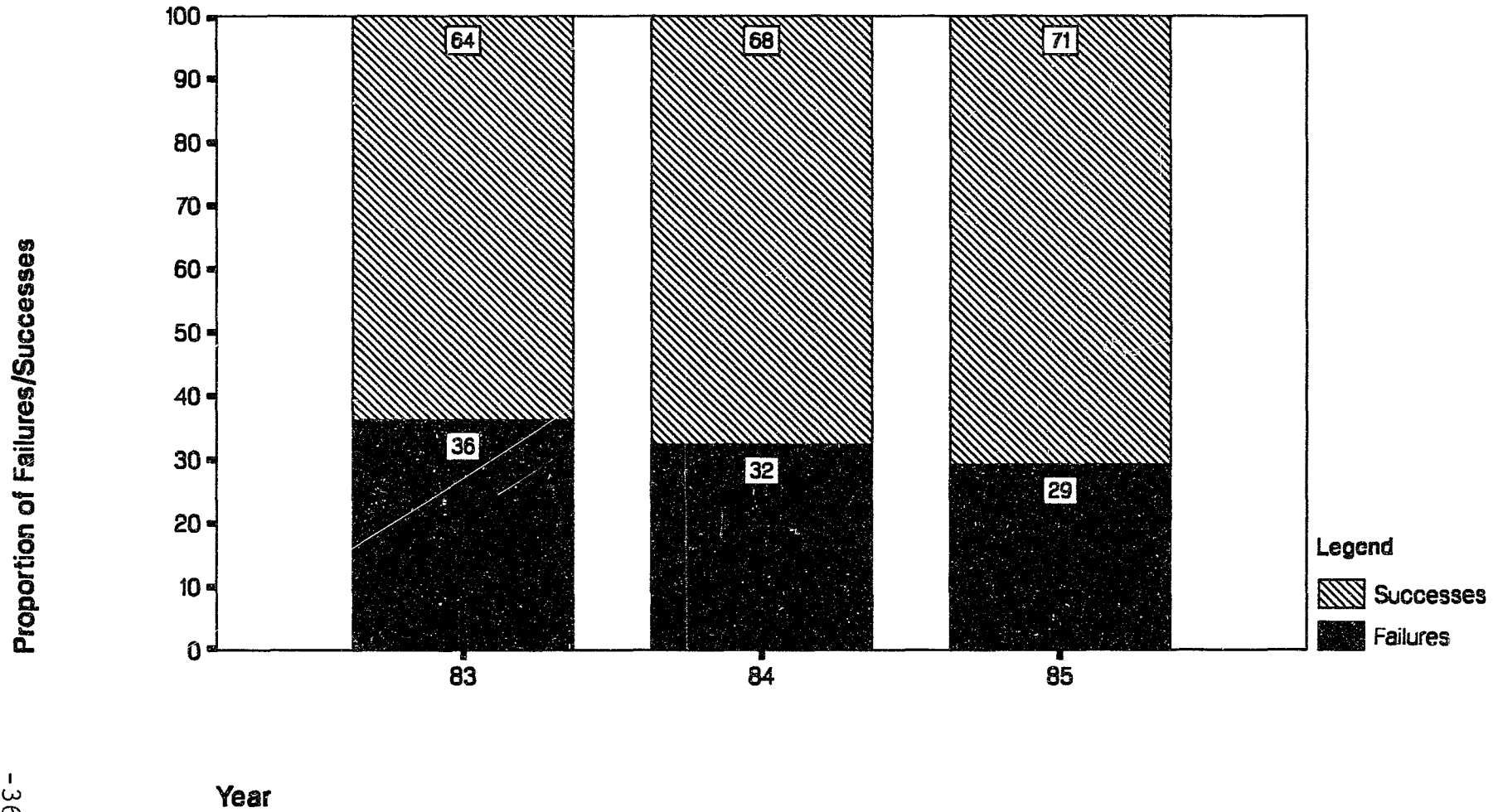

Recidivism in this study was defined as any rearrest after program intake date and included only those offenders admitted in 1983, 1984, and 1985. The follow-up period for the 1983 sample ranged from four to five years, for the 1984 sample three to four years, and for the 1985 sample two to three years. The data reflect a change in rearrest percentages as the follow-up period increases. Thirty-six per cent of the 1983 clients, 32 per cent of the 1984 clients, and 29.1 per cent of the 1985 clients had been rearrested by 1 December 1987. It may be assumed that the rates would climb for 1984 and 1985 as more time elapsed from intake date.

Both the total figures and the figures for individual years are similar to recidivism rates reported in studies of other pretrial diversion programs.

The study attempted to determine what factors, if any, could be associated with program failure. Those personal characteristics reported in the recidivism literature were assessed for the PTI sample, and the findings paralleled those of other researchers. As might be expected from the literature (e.g., Wallerstedt, 1984) age is the best predictor of program failure, with offenders under 25 twice as likely to be rearrested as those over 35. In Figure VIII offenders are grouped into five age categories. The table clearly illustrates the decrease in the likelihood of rearrest as age at intake increases.

Sex, race and education level were the other personal characteristics examined for any association with recidivism (See Figure IX Rearrest by Personal and Legal Characteristics). As was expected, female clients were considerably less likely than male clients to be rearrested (24.6% compared to 35.3%). Those clients who had neither a high school diploma nor its equivalent recidivated at a much greater rate (41.3%) than those who had completed high school (29.9%). This, too, was not an unexpected finding, since education level has been found in other studies to be

Figure VIII. Rearrest by Age

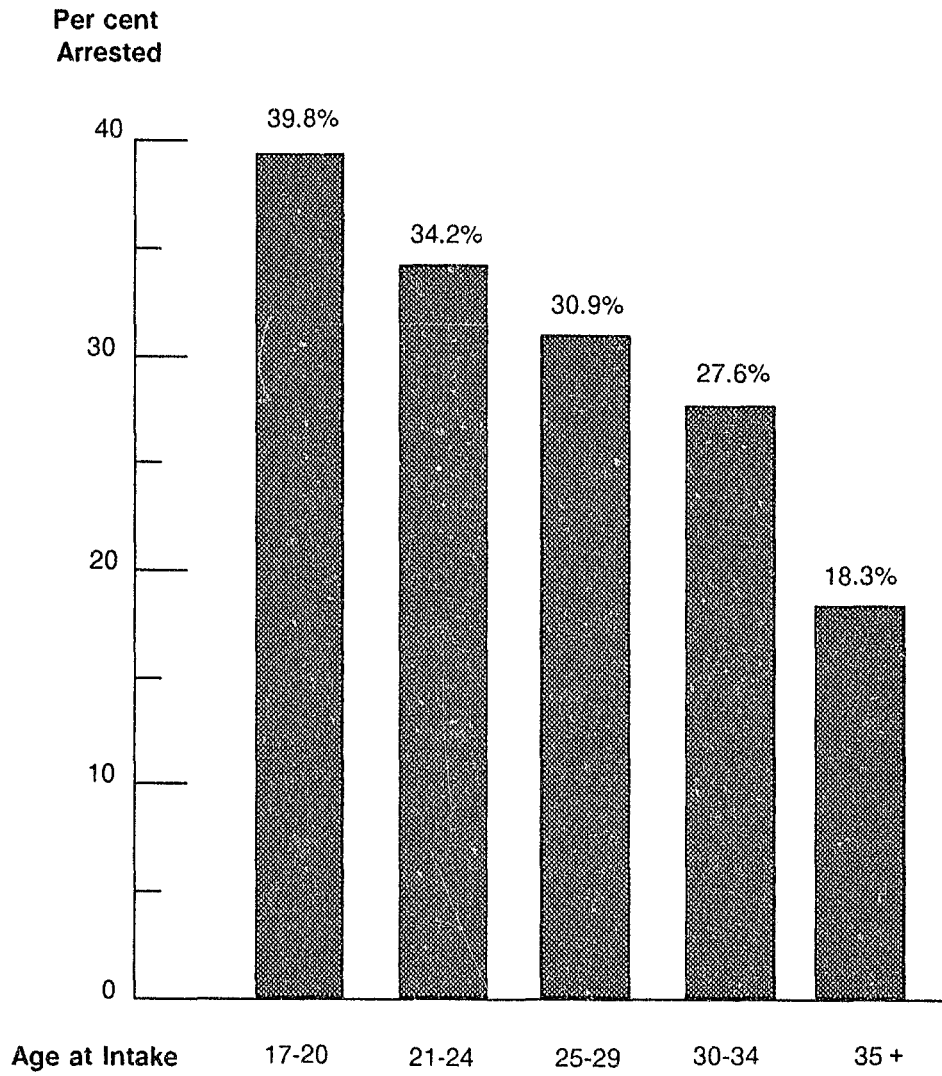

associated with recidivism. Race, however, does seem to have a relationship with rearrest after intake date.

Figure IX. Recidivism Rates

| Rates of rearrest by Selected personal and legal characteristics Sample = 1753 | | | | |
|--|---------|------|---------|------|
| | Success | | Failure | |
| | # | % | # | % |
| Sex | | | | |
| Male | 863 | 64.7 | 471 | 35.3 |
| Female | 316 | 75.4 | 103 | 24.6 |
| Education | | | | |
| H S Diploma | 920 | 70.1 | 392 | 29.9 |
| No Diploma | 259 | 58.7 | 182 | 41.3 |
| Race | | | | |
| Black | 57 | 67.1 | 28 | 32.9 |
| White | 852 | 69.3 | 378 | 30.7 |
| Native | 220 | 59.8 | 148 | 40.2 |
| Other | 50 | 71.4 | 20 | 28.6 |
| Alcohol Problem | | | | |
| no | 597 | 73.7 | 213 | 26.3 |
| yes | 582 | 61.7 | 361 | 38.3 |
| Offense Severity | | | | |
| Misdemeanor | 760 | 69.1 | 341 | 30.9 |
| Felony | 418 | 64.1 | 234 | 35.9 |
| Prior Record | | | | |
| No Prior | 804 | 72.4 | 307 | 27.6 |
| Prior | 375 | 58.4 | 267 | 41.6 |

Alaska Natives were more likely to be rearrested than any other racial or ethnic group in the sample. Blacks were more likely to be arrested than either whites or other (Asian, Pacific Islander, Hispanic, etc.). Alaska Natives are likely to live in small communities, and it may be that rearrest is more likely in small communities where behaviors are more noticeable. Certainly the literature on

intensive supervision has suggested that offenders who are more closely watched are more likely to be caught engaging in inappropriate behavior. More than half of the Alaska Natives in the PTI sample lived in rural areas (51.9%) while only 20.7 per cent of the whites in the sample lived in non-urban areas. Blacks, on the other hand, were more likely to live in urban areas yet their rate of rearrest was greater than that of whites.

In Alaska problems with alcohol appear to be very common. The newspapers, mental health professionals and criminal justice professionals are especially concerned with the high alcohol consumption in the state, and some Native villages have opted to keep alcohol out of their villages under the state's local option law. In the recidivism sample 40.02 per cent of PTI offenders were under the influence of alcohol at the time of their offense and 32.9 per cent had been deemed to have an alcohol problem.

Since several data elements addressed the possible abuse of alcohol these were combined into a single variable (alcohol problem) in order to examine rearrest patterns of offenders whose offense behavior or personal histories indicated problems with alcohol. In addition to those who had been under the influence at the time of the instant offense or those who had been found to have had an alcohol problem, this new variable included clients who had been in alcohol programs at or prior to intake or those who had been referred to alcohol counseling as part of their PTI contracts. Of the 943 participants who seemed to have an alcohol problem, 38.3 per cent were rearrested after intake date compared with 26.3 per cent of the 810 clients for whom no indication of problems associated with alcohol was found.

The alcohol use variable was cross-tabulated with race in order to ascertain if the data provided any support for the widely accepted view that Alaska Natives seldom violate state criminal statutes unless alcohol is associated with their

behavior. Of the 368 Alaska Natives in the recidivism sample, 80.2 per cent were included in the alcohol use variable, lending some credence to this view.

Certain legal characteristics were also examined to see if these were associated with rearrest (See Figure IX). Offense severity (whether the client's intake charge was a felony or a misdemeanor) was not associated with recidivism. Of the 574 PTI failures, 340 (59.2%) had been admitted to the program after a misdemeanor or arrest and 234 (40.8%) had been admitted after felony arrests. While proportionally more felons were rearrested than misdemeanants (35.9 compared to 30.9) the difference is trivial.

The difference between those with prior records and those whose records were clear, however, is substantial. Included in the prior offender category were pending charges as well as previous offenses. The bulk of offenders with prior records (N=642) had either juvenile records (224), records of misdemeanor offenses (N=262) or of driving while intoxicated (N=117). Of those with juvenile records 43.8 per cent were rearrested after their PTI intake offense; of those with misdemeanor records, 42.7 per cent were rearrested. Those with a prior record of driving while intoxicated were rearrested at a lesser rate (35.7%).

Pretrial diversion programs are usually intended for first offenders whose offenses are relatively minor and who would be best served by a lesser penalty than either incarceration or probation. Programs which operate in this way appear from the literature to be likely to widen the net rather than serve as alternatives to more severe sanctions. The Alaska Pretrial Intervention program deliberately set policies to avoid net widening and may have therefore increased the risk that there would be program failures. The failure rate for those in the sample with prior records does not justify excluding them from participation in diversion programs since this recidivism rate is in the range for other programs elsewhere. The literature on

recidivism suggests that the number of prior arrests is linked to the likelihood of recidivating (Illinois Criminal Justice Information Authority, 1987; Beck, 1987; and others). Perhaps candidates with prior records should be more carefully screened for admission to alternative sentencing programs, but they should not be eliminated from consideration since nearly sixty percent of the ones in this study were not rearrested after intake.

When the sample was broken down by intake offense the recidivism rates continued to be within the expected range. The offense figures are shown in Figure X. Only the first six offenses appeared frequently enough as intake offenses to seriously be considered in a discussion of client failure. Rearrest rates for clients who committed offenses which appeared less than 100 times are also in the expected range.

For the most frequent offenses rearrest rates range from 25 per cent to more than 40 per cent. Burglary perhaps should not have been combined with criminal trespass since burglary is a felony and trespass a misdemeanor. In fact there were 122 PTI clients charged with burglary and only 74 charged with trespass. Interestingly, the rearrest rates were substantially similar when the offenses were broken out. Fifty-one of the clients charged with burglary were rearrested (41.8%) and 29 of the clients charged with trespass were rearrested (39.2%).

We also examined clients who were rearrested for the same offense with which they had been charged at program intake. A total of 137 (7.8%) PTI clients were rearrested on the same offense as their intake offense. All but six had been charged with the most frequent offenses: theft, drugs, burglary/trespass, assault and minor consuming. The six other offenses included two charges of fraud and two of weapons misconduct and one each of disorderly conduct and contributing to the delinquency of

Figure X. Success/Failure by Instant Offense

| Most Frequent | Total N | Success | | Failure | |
|--------------------------------------|---------|---------|------|---------|------|
| | | # | % | # | % |
| theft | 486 | 339 | 69.8 | 147 | 30.2 |
| drugs | 216 | 162 | 75.0 | 54 | 25.0 |
| minor consuming | 200 | 128 | 64.0 | 72 | 36.0 |
| Burglary/trespass | 196 | 113 | 57.7 | 83 | 42.3 |
| assault | 184 | 128 | 69.6 | 56 | 30.4 |
| criminal mischief | 137 | 77 | 56.2 | 60 | 43.8 |
| Other | | | | | |
| forgery | 75 | 45 | 60.0 | 30 | 40.0 |
| weapons misconduct | 46 | 33 | 71.7 | 13 | 28.3 |
| disorderly conduct | 31 | 20 | 64.5 | 11 | 35.5 |
| fraud | 31 | 20 | 64.5 | 11 | 35.5 |
| contribute to delinquency of a minor | 28 | 20 | 71.4 | 8 | 28.6 |
| perjury/false swearing | 24 | 23 | 95.8 | 1 | 04.2 |
| other | 99 | 71 | 71.7 | 28 | 28.3 |

a minor. Theft was the offense category with the most repeaters, 42; minor consuming was second with 30 and assault was third with 28. Seventeen persons were rearrested for drug violations and 15 for burglary/trespass.

The mean age of same offense repeaters was 23.8, with the mean for minor consuming 18.3 years for the youngest and the mean for assault 28.4, the oldest of the 139 in the sample. Twenty-two of these recidivists were female and more than half (51.1%) had successfully completed their pretrial contracts.

Figure XI. Pace of Recidivism by Legal Variables
(N = 574)

A. Time from Intake Date to Rearrest by Offense Severity

| | Months | Misdemeanants | | Cum. % | Felons | | Cum. % |
|-------|--------|---------------|------|-----------|--------|------|-----------|
| | | # | % | | # | % | |
| 1 yr | 0-6 | 123 | 36.2 | 36.2 | 75 | 32.0 | 32.0 |
| | 6-12 | 79 | 23.2 | 59.4 | 53 | 22.6 | 54.6 |
| 2 yrs | 12-18 | 42 | 12.3 | 71.7 | 32 | 13.7 | 68.3 |
| | 18-24 | 50 | 13.9 | 85.6 | 26 | 10.7 | 79.0 |
| 3 yrs | 24-30 | 22 | 6.4 | 92.0 | 15 | 6.4 | 85.4 |
| | 30-36 | 13 | 3.9 | 95.9 | 17 | 7.3 | 92.7 |
| 4 yrs | 36-42 | 6 | 1.8 | 97.7 | 11 | 4.7 | 97.4 |
| | 42-48 | 5 | 1.5 | 99.2 | 3 | 1.3 | 98.7 |
| | 48-56 | 3 | .9 | 100.1* | 3 | 1.3 | 100.0 |

B. Time from Intake Date to Rearrest by Prior Record

| | Months | Prior | | Cum. % | No Prior | | Cum. % |
|-------|--------|-------|------|-----------|----------|------|-----------|
| | | # | % | | # | % | |
| 1 yr | 0-6 | 103 | 38.6 | 38.6 | 95 | 31.0 | 31.0 |
| | 6-12 | 60 | 22.5 | 61.1 | 72 | 23.5 | 54.5 |
| 2 yrs | 12-18 | 32 | 12.0 | 73.1 | 42 | 13.7 | 68.2 |
| | 18-24 | 28 | 10.5 | 83.6 | 44 | 14.3 | 82.5 |
| 3 yrs | 24-30 | 17 | 6.4 | 90.0 | 20 | 6.5 | 89.0 |
| | 30-36 | 14 | 5.2 | 95.2 | 16 | 5.2 | 94.2 |
| 4 yrs | 36-42 | 10 | 3.7 | 98.9 | 7 | 2.3 | 96.5 |
| | 42-48 | 2 | .8 | 99.7 | 6 | 2.0 | 98.0 |
| | 48-56 | 1 | .4 | 100.1* | 5 | 1.7 | 100.2* |

* does not total 100.0 due to rounding

Note: Months was determined by assigning values to variable Days/91 which made precise divisions impossible.

So few of the recidivists were rearrested for the same offense that no conclusions can be drawn from the data. Assault, which is the only non-property crime considered for the Alaska pretrial intervention program, is a special case. Persons charged with assault were very likely to have been charged in connection with domestic violence, behavior which does not respond readily to intervention. Of the 28 same offense repeaters charged with assault, 25 had had a history of domestic violence. All of them were rearrested more than once on this charge after their intake assault offense. Groups concerned with this behavior in Alaska had not been enthusiastic about pretrial diversion as an option for abusers. This pattern suggests that they were right to be doubtful.

Recidivism studies suggest that the first year is the critical period for recidivists (Wallerstedt, 1984). The Illinois Criminal Justice Information Authority (1985) found the critical period to be in the first nine months after release from prison. In their sample 35 per cent were rearrested in the first six months after release from prison and 40 per cent after the first nine months.

Recidivists in the Alaska pretrial sample were rearrested at similar rates although these less serious offenders were arrested more quickly. Time to rearrest was measured by the time to the first arrest after the client's intake date. Figure XI shows the length of time in months between intake date and date of rearrest. In the first six months after release 34.5 per cent of PTI recidivists were rearrested and in the first nine, 47.0 per cent were rearrested. Wallerstedt suggests that offenders who remain crime-free for three years after release from prison have a good chance of not recidivating. The figures suggest support for this view, since 94.5 per cent of the total sample of PTI recidivists had been rearrested by three years after intake date.

The studies noted also examined offense severity and prior record. The PTI rearrest rates remain relatively constant over these variables. Though the felons in our sample had not committed dangerous crimes their crimes were legally more serious than those of the misdemeanants, yet 36.2 per cent of the misdemeanants and 32.0 per cent of the felons were rearrested in the first six months and in the first year 59.4 per cent of misdemeanants and 54.6 per cent of felons.

Figure XII. Recidivism by Program Disposition

| Unfavorable | Success | | Failure | |
|--------------------------|------------|-------------|------------|-------------|
| | # | % | # | % |
| arrest or conviction | 18* | 21.4 | 66 | 78.6 |
| noncompliance | 59 | 55.7 | 47 | 44.3 |
| partial compliance | 114 | 54.3 | 96 | 45.7 |
| Total Unfavorable | 191 | 47.8 | 209 | 52.3 |
| Favorable | Success | | Failure | |
| | # | % | # | % |
| partial compliance | 130 | 58.3 | 93 | 41.7 |
| total compliance | 857 | 76.0 | 272 | 24.0 |
| Total Favorable | 987 | 73.1 | 365 | 26.9 |

* Twenty-three of the clients in the recidivism sample were admitted to the program while charges were pending on offenses other than the intake offense. These did not appear in the rearrest data since the arrest occurred before intake date. A conviction on any pending charge resulted in an unfavorable disposition. A sentence to jail on one of these charges could explain the "success" of some of these clients.

The data were originally expressed in days rather than months and an initial examination of the data showed that program failures who had been charged with misdemeanors were rearrested an average 360 days after intake date while failures charged with felonies were rearrested an average 429 days after intake. While the data appeared to show that felons were slower to recidivate than misdemeanants, we must note that felony offenders tended to be under contract for longer periods. Thus the data suggest that counselor supervision and offender involvement in treatment and community work service programs serve to prevent clients from engaging in illegal activity during their contract periods.

Those recidivists with prior records (N=267) recidivated more rapidly than those whose records were clear but not excessively so. In the first six months 38.6 per cent were rearrested compared to 31.0 per cent of those without prior records, and in the first year 61.1 per cent had been rearrested compared with 54.5 per cent of those without prior records.

Results of evaluations of other pretrial diversion programs have found that persons who successfully completed the program were more likely to succeed (remain unarrested) during the follow-up period. This was certainly so in the current study, since the 84 clients who were rearrested while under a PTI contract received unfavorable dispositions and were counted as rearrests after intake. Under this measure of recidivism 52.3 per cent of those who received unfavorable dispositions were failures, compared with 26.9 per cent of those who received favorable dispositions. There were several criteria used for disposition decisions (See Figure XII). Partial compliance with program requirements might result in either a favorable or an unfavorable disposition. The failure rates for clients who only partially completed the program are similar regardless of disposition and the rates for non-compliance are in the same range. While program completion might be a

good predictor of rearrest, it is not a particularly valid way of evaluating program effectiveness. It is of some interest that nearly two-thirds of the PTI clients fully completed the program, since retention might be used as an indicator of the program's utility.

Another possible measure of program effectiveness is the length of the PTI contract. The study suggests that the longer a client is in the program the less likely he/she is to recidivate. Of those in the program for fewer than three months 58.2 per cent were rearrested, but of those in the program for nine to twelve months only 28.6 per cent were rearrested. This suggests that the longer the client is under PTI supervision the more likely he is to complete the requirements of the contract and that reporting to his counselor, engaging in community service activities, attending those treatment programs to which he was referred, etc., does, over time, have an impact on subsequent behavior.

Another measure is the degree of the client's participation in those treatment programs to which he is referred. Client release forms included an assessment of compliance with treatment requirements. For example, 585 clients were referred to alcohol counseling programs. Of these, 94 did not participate and 53.2 per cent of them were rearrested, 105 partially completed the program and 51.4 per cent were rearrested. Of the 373 who fully completed the program 35.9 per cent were rearrested.

Summary and Recommendations

Throughout the planning, trial and statewide operation stages of the program the Alaska Department of Law was committed to the establishment of a thorough evaluation of the Pretrial Intervention Program. The cooperative agreement with the Justice Center to collect and verify raw data from admission and release forms was unique to Alaska. This agreement included cooperation between PTI and Justice Center staff in the design of the forms and a commitment on the part of PTI staff to complete the forms with care and forward them regularly to the Center for computer entry. The result was a complete computerized data base which was used for this report.

The data show that the Alaska Pretrial Intervention operated successfully on a variety of measurements throughout the period of its existence. It met intake goals and was available to a broad spectrum of Alaska citizens; two-thirds of the clients admitted to the program have no record of any subsequent law violations.

One of the basic policies governing the program was that it admit only prosecutable offenders. All of the available evidence shows that this policy was followed; the PTI program did not increase the number of persons caught in the criminal justice net. In this it achieved a goal of "minimum penetration" and avoided potential strain at further points in the Alaska criminal justice system: the courts, the Division of Probation, and correctional institutions.

One of the keys to successful avoidance of net widening was that the program operated under the same agency which governs prosecution throughout the state. Because the program was a part of their own organization Alaska prosecutors tended to view PTI as an alternative rather than as a program to which nonprosecutable cases could be referred. This is a major difference between the Alaska PTI program and those reported in the literature: most of these were operated by agencies with no

direct links to the prosecutor's offices, and, as a result, prosecutor referrals were not governed by program policies but instead were dependent on prosecutor perceptions of the utility of the particular program.

The Alaska program was successful in providing alternatives to more severe sanctions for nearly 1900 Alaskans throughout the state. The opportunity to avoid a criminal conviction was not directed at specific population groups but was available to a variety of Alaskans of all ages, races and socioeconomic levels as long as their offenses were not violent or, in the case of property crimes, not of a serious or threatening nature.

PTI clients were as young as 17 and as old as 66 at intake date, with an average age of 26 years. One quarter of the clients had not completed high school (25.2%) although some were quite well-educated; 454 had been to college (24.3%) and 34 had advanced degrees. At intake 31.9 per cent of clients were unemployed (N = 595) and 40.9 per cent (N = 763) were employed full-time.

A substantial proportion of the men and women in the program were long-term Alaska residents; their average length of time in residence was 13.8 years. However, the program was available to newcomers since approximately a quarter of the clients had been in residence for less than four years. While whites constituted the overwhelming majority of PTI clients (69.5%), the program served a substantial number of Alaska Natives. Their representation in the sample (21.3%) was greater than their representation in the general population (16.0%) as was the representation of Blacks, 5.0 per cent in the program compared to 3.3 per cent of the general population.

This demonstrated heterogeneity of PTI clients reveals that admission to the program was not based on a determination that some kinds of people are more

deserving of an opportunity to avoid a criminal conviction than others, but rather on published guidelines regarding offense eligibility and case quality.

Program guidelines required that, except for domestic violence offenses, eligible clients would be charged with less serious property or public order offenses. The data show that theft, drug offenses, burglary/trespass, assault and minor consuming were the most frequent offenses charged to clients in the program, but there were several offenses which appeared more rarely - some only once, others as many as 76 times. The appearance of some of these offenses in the data base indicates that local prosecutors were free to make referrals based on local problems and needs. Although operated by a state agency the pretrial diversion program did accommodate the special concerns of widely scattered Alaska communities with different populations and environments. More than a third of the program's participants had been charged as felons (36.8%) and almost as many (36.3%) were not first offenders. All of the charges were within the Department of Law's established policies for Pretrial Intervention Program eligibility.

The statewide nature of the program permitted a variety of Alaskans to take advantage of this alternative sanction. Participation in the program permitted them to remain in their communities and it benefited those communities. Community needs which would otherwise have gone unmet were fulfilled through the community service requirements of the PTI program. Placement into work service depended upon client abilities and community needs. Placement included: youth work, janitorial work, work for non-profit agencies, hospitals, etc. The work performed cannot be work normally done by someone in a paid position. Statewide they completed 65,302 hours of community service between 1983 and mid-1986. In addition, the 1864 clients paid a total of \$435,081 in monetary restitution to victims.

PTI clients not only engaged in many hours of community service, but also participated in a number of needed treatment programs to which they were referred, including alcohol counseling, psychological counseling, domestic violence counseling, career counseling. We can assume that a substantial portion of them were helped by these programs since 65 per cent of the PTI clients had not been rearrested 2 - 4 1/2 years after entering the program.

All available evidence from this complete and detailed data base shows that the Alaska Pretrial Intervention program operated successfully for more than three years - 1983 to mid-1986. Ironically, this program, which provided a desirable and cost effective disposition to a broad spectrum of the state's citizens, was phased out when the Alaska economy began to falter. Since 1983 three new correctional facilities have opened and the state's crime rate has begun to decline. This suggests that Alaska will not see any need to reinstitute a low-cost alternative to incarceration or probation. In spite of its success, the Alaska Pretrial Intervention Program will not, in the foreseeable future, again be available to erring citizens of the state.

This evaluation of the Alaska pretrial diversion experience gives rise to a number of recommendations for the organization and operation of diversion programs and for research into human services programs of all kinds.

- 1. The office of the prosecutor should be a co-sponsor or partner in pretrial diversion programs with the responsibility to assure that only prosecutable cases are referred for admission. While the centralization of the Alaska program under a state prosecutorial agency resulted from a special feature of the organization of the criminal justice system in Alaska which cannot be duplicated elsewhere, the advantages it demonstrates could be incorporated into local programs. Adding nonprosecutable cases to the**

criminal justice system is not cost-effective. Only the office of the prosecutor can assure that net widening is avoided.

2. **Eligibility guidelines should be clear and specific and should be based primarily on offense behavior and defendant record, and not on personal or social characteristics.** Because participants are assured that charges will be dropped upon completion of their diversion contracts pretrial diversion is viewed as a mild sanction which allows offenders to avoid the stigma of a criminal conviction. Personal and social characteristics may be used to decide if a conviction is inappropriate. While this is an acceptable function of diversion programs, attention to legal variables will help to assure that all erring citizens have access to the program and that diversion is a true alternative to more severe penal sanctions.
3. **Because minorities are overrepresented in the nation's jail and prison populations, minority clients should also be overrepresented in diversion populations compared to their representation in the general population.** Attention to the minority composition of diversion clients can help to assure that the program is serving as an alternative disposition and that legal variables as well as social ones are included in the referral decision.
4. **Rates of client recidivism should be used to assess adherence to program guidelines as well as program effectiveness.** Diversion programs which serve nonprosecutable offenders will have artificially low recidivism rates; diversion programs which serve only prosecutable offenders will have recidivism rates comparable to those of other community-based programs.
5. **Ongoing evaluation research by an independent agency should be incorporated into the program at program initiation.** Both researchers and staff should be involved in the design of the evaluation and the procedures

for data collection. The model developed by the Department of Law and the Justice Center can assure an accurate basis for program decisions including policy changes and changes in priorities.

BIBLIOGRAPHY

- Alaska Advisory Committee on Minority Judicial Sentencing Practices (1980) Report of the Committee, Alaska Legislature. Juneau, AK.
- Alaska Department of Corrections (1985) Annual Report, Department of Corrections. Juneau, AK.
- Alaska Department of Labor (1985) Alaska Population Overview. Juneau, AK.
- Agopian, M.S. (1977) "Evaluation of Adult Diversion Programs: The California Experience." *Federal Probation Quarterly* 41(3):15-18.
- Baker, S.H. and Sudd, S. (1981) Diversion of Felony Arrests: An Experiment in Pretrial Intervention. Vera Institute of Justice, National Institute of Justice. Washington, DC: U.S. Department of Justice.
- Beck, A.J. (1987) *Recidivism of Young Parolees*. Bureau of Justice Statistics Special Report. Washington, DC: Bureau of Justice Statistics.
- Blomberg, T.G. (1980) "Widening the Net: An Anomaly in the Evaluation of Diversion Programs." In *Handbook of Criminal Justice Evaluation*, M.Klein and K.S. Teilman. Beverly Hills, CA: Sage Publishing.
- Binder, A. and Geis, G. (1984) "Ad populem Argumentation in Criminology: Juvenile Diversion as Rhetoric." *Crime and Delinquency* 30:309-333.
- Bohnstedt, M. (1978) "Answers to Three Key Questions about Juvenile Diversion." *Journal of Research in Crime and Delinquency* 15:109-123.
- Cobb, D. (1981) *Pre-Trial Intervention Training Manual*. Juneau, AK: Alaska Department of Law.
- Decker, S. (1985) "A Systematic Analysis of Diversion: Net Widening and Beyond." *Journal of Criminal Justice* 13(3):207-216.
- Dunford, F.W.; Osgood, D.W. and Weichselbaum (1982) *National Evaluation of Diversion Projects*. Washington, DC: U.S. Department of Justice, Office of Juvenile Justice and Delinquency Prevention.
- Elliot, D.S., Dunford, F.N. and Knowles, B. (1978) *Diversion: A Study of Alternate Sentencing Practices*. Boulder, CO: Behavior Research Institute as cited by Polk.
- Gibbons, D. and Blake, G. (1976) "Evaluating the Impact of Juvenile Diversion Programs." *Crime and Delinquency* 22:411-420.
- Haapanen, R. and Rudisill, D. (1980) *The Evaluation of Youth Service Bureaus: Final Report*. Sacramento, CA: California Youth Authority.
- Hillsman, S.T. (1982) "Pretrial Diversion of Youthful Adults: A Decade of Reform and Research." *The Justice System Journal* 7(3):361-387.

- Hoffman, P.B. and Stone-Meierhoefer, B. (1979) "Post-release Arrest Experiences of Federal Prisoners: A Six-Year Follow-up." *Journal of Criminal Justice* 7(3):193-216.
- _____ (1980) "Reporting Recidivism Rates: The Criterion and Follow-up Issues." *Journal of Criminal Justice* 8(2):53-60.
- Illinois Criminal Justice Information Authority (1987) "Repeat Offenders in Illinois: Recidivism Among Different Types of Prison Releases." *Research Bulletin*, State of Illinois.
- Johnson, K.W. (1982) "The Alaska Pretrial Intervention Evaluation Development Project." Anchorage, AK: Justice Center, University of Alaska, Anchorage.
- Klein, M. (1980) "Deinstitutionalization and Diversion of Juvenile Offenders: A Litany of Impediments." In *Crime and Justice: An Annual Review*, N. Morris and M. Tonry, eds. Chicago, IL: University of Chicago Press.
- Lahners, R. and McMasters, E.A. (1981) *1978 Felony Diversions: An Assessment of Recidivism, System Impact and Cost Effectiveness*. Lincoln, NE: The Lancaster County Pretrial Diversion Program (NCJRS 78358).
- Lincoln, L. (1976) "Juvenile Referral and Recidivism," in R.M. Carter and M.W. Klein, eds. *Back on the Street: Diversion of Juvenile Offenders*. Englewood Cliffs, NJ: Prentice Hall.
- NAPSA (1978) *Diversion: Performance Standards and Goals for Pretrial Release and Diversion*. Washington, DC: U.S. Government Printing Office.
- Palmer, T. (1979) "Juvenile Diversion: What and For Whom?" *California Youth Authority Quarterly* 32:14-20.
- Palmer, T. and Lewis, R. (1980) "A Differential Approach to Juvenile Diversion." *Journal of Research in Crime and Delinquency* 17:209-277.
- Partch, S.; Edwards S.M. and Johnson, K.W. (1984) "Evaluation Capacity Building in Pretrial Diversion Services: A Case Study." Anchorage, AK: The Justice Center, University of Alaska, Anchorage.
- Pennsylvania Commission on Crime and Delinquency (1987) "The Adult First Offender Program in Pennsylvania: Characteristics, Dispositions and Recidivism." *The Justice Analyst*. Pennsylvania Commission on Crime and Delinquency.
- Polk, K. (1984) "Juvenile Diversion: A Look at the Record." *Crime and Delinquency* 30(4):648-659.
- Potter, R.H. and Starnes, S.M. (1981) *Florida Statewide Alternatives to Street Crime: Final Evaluation Report* (NCS 93044).
- Pryor et al. (1977) "Pretrial Diversion Program in Monroe County, New York: An Evaluation of Program Impact and Cost Effectiveness." *PreTrial Services Annual Journal*. Washington, DC: Pretrial Services Resource Center.

- Pryor, D.E. (1982) "Practices of Pretrial Diversion Programs: Review and Analysis of Data." *Pretrial Issues*. Washington, DC: Pretrial Services Resource Center.
- Pryor, D.E. and Smith, W.F. (1983) *Alternatives to Prosecution: A Review of Recent Research Findings*. Washington, DC: Pretrial Services Resource Center.
- Quay, H.C. and Love, C.T. (1977) "The Effect of a Juvenile Diversion Program on Rearrests." *Criminal Justice and Behavior* 4:377-396.
- Ring, P.S. and Bruce, K.K. (1980) *Evaluation of Pretrial Diversion Project, State of Alaska, Department of Law*. Anchorage, AK: Justice Center, University of Alaska, Anchorage.
- Rovner-Pieczenik, R. (1974) "Pretrial Intervention Strategies: An Evaluation of Policy-Related Research and Policymaker Perceptions." Washington, DC: National Pretrial Intervention Service Center, American Bar Association.
- Wallerstedt, J. (1984) "Returning to Prison." Bureau of Justice Statistics Special Report. Washington, DC: U.S. Department of Justice.

APPENDIX 1

PRETRIAL INTERVENTION FELONY REFERRAL PROCEDURE

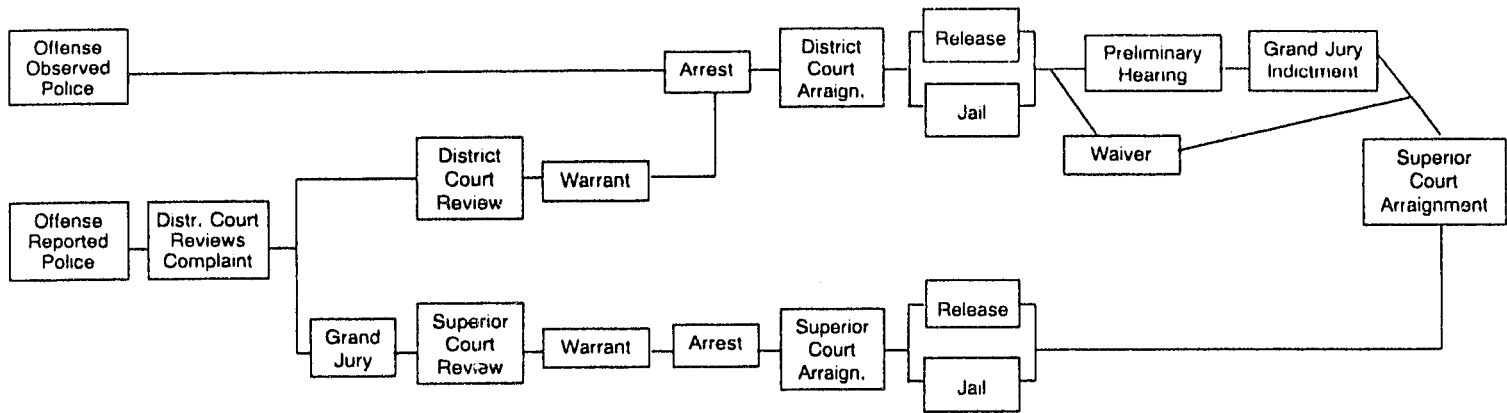

PRETRIAL INTERVENTION FELONY REFERRAL PROCEDURE (continued)

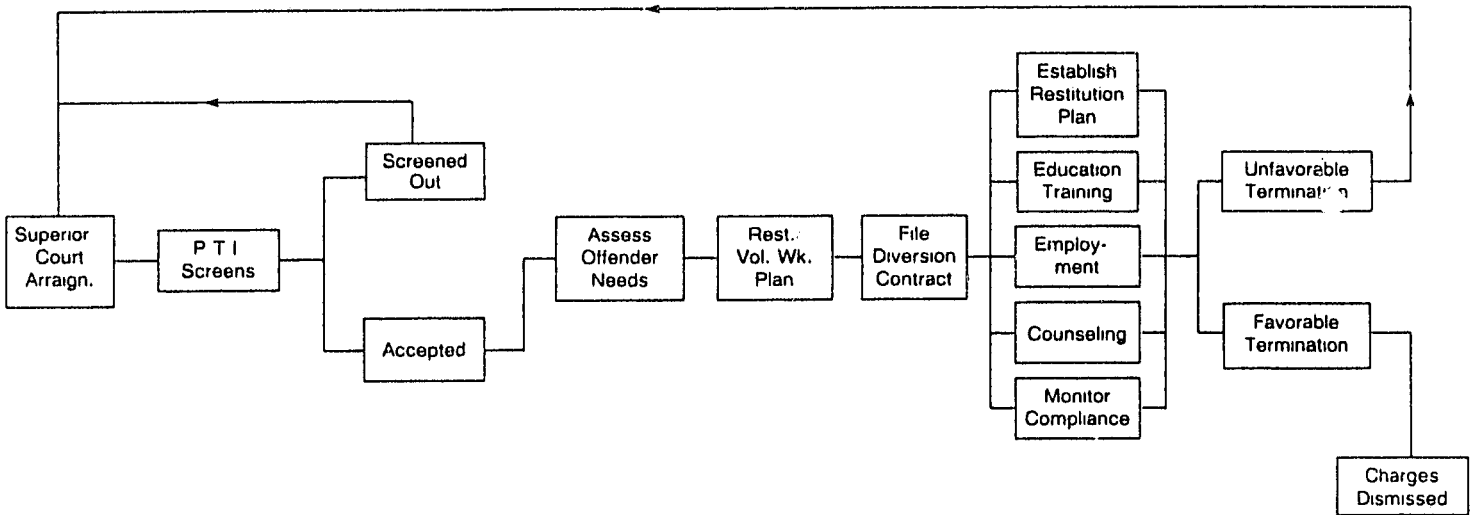

PRETRIAL INTERVENTION MISDEMEANANT REFERRAL
PROCEDURE

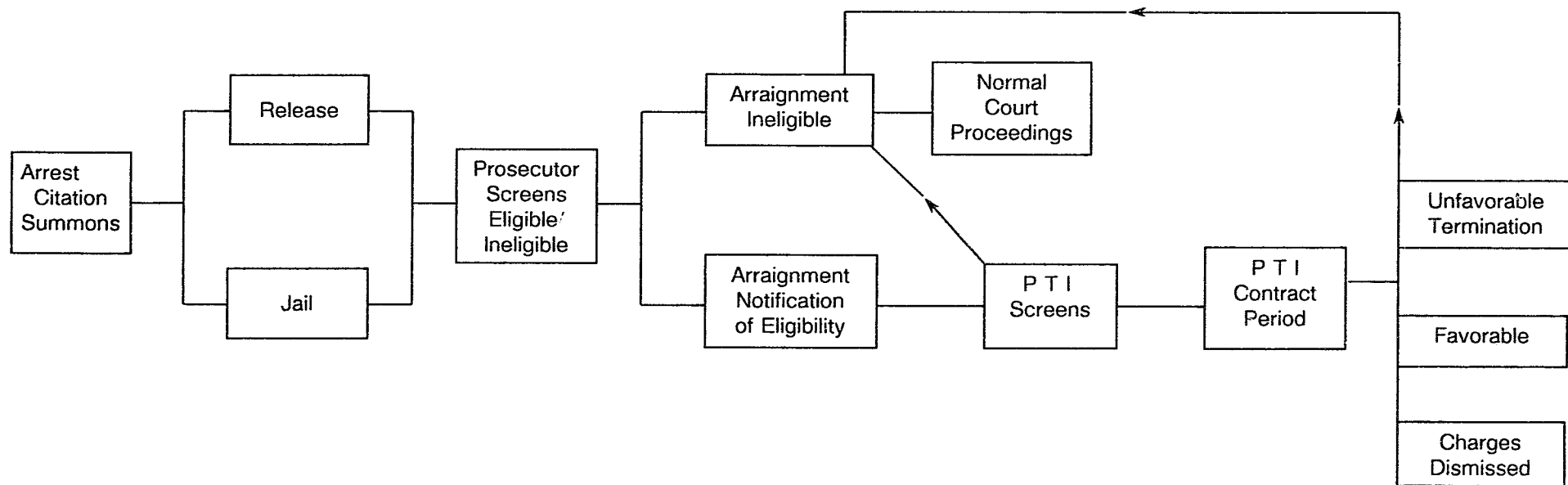

| | | | | | | | | | | | | | | | | | | | | | | | | | | | | | | | | | | | | | | | | | | | | | | | | | | | | | | | | | | | | | | | | | | | | | | | | | | | | | | | | | | | | | | | | | | | | | | | | | | | | |
|--|---|---|---|---|---|---|---|---|---|----|----|----|----|----|----|----|----|----|----|----|----|----|----|----|----|----|----|----|----|----|----|----|----|----|----|----|----|----|----|----|----|----|----|----|----|----|----|----|----|----|----|----|----|----|----|----|----|----|----|----|----|----|----|----|----|----|----|----|----|----|----|----|----|----|----|----|----|----|----|----|----|----|----|----|----|----|----|----|----|----|----|----|----|----|----|----|----|----|----|----|
| 1. DEFENDANT I.D. (CARD #) | 1 | 2 | 3 | 4 | 5 | 6 | 7 | 8 | 9 | 10 | 11 | 12 | 13 | 14 | 15 | 16 | 17 | 18 | 19 | 20 | 21 | 22 | 23 | 24 | 25 | 26 | 27 | 28 | 29 | 30 | 31 | 32 | 33 | 34 | 35 | 36 | 37 | 38 | 39 | 40 | 41 | 42 | 43 | 44 | 45 | 46 | 47 | 48 | 49 | 50 | 51 | 52 | 53 | 54 | 55 | 56 | 57 | 58 | 59 | 60 | 61 | 62 | 63 | 64 | 65 | 66 | 67 | 68 | 69 | 70 | 71 | 72 | 73 | 74 | 75 | 76 | 77 | 78 | 79 | 80 | 81 | 82 | 83 | 84 | 85 | 86 | 87 | 88 | 89 | 90 | 91 | 92 | 93 | 94 | 95 | 96 | 97 | 98 | 99 | 00 |
| 2. P.T.I. LOCATION (SEE SUPPLEMENTAL FORM FOR CODES) | 1 | 2 | 3 | 4 | 5 | 6 | 7 | 8 | 9 | 10 | 11 | 12 | 13 | 14 | 15 | 16 | 17 | 18 | 19 | 20 | 21 | 22 | 23 | 24 | 25 | 26 | 27 | 28 | 29 | 30 | 31 | 32 | 33 | 34 | 35 | 36 | 37 | 38 | 39 | 40 | 41 | 42 | 43 | 44 | 45 | 46 | 47 | 48 | 49 | 50 | 51 | 52 | 53 | 54 | 55 | 56 | 57 | 58 | 59 | 60 | 61 | 62 | 63 | 64 | 65 | 66 | 67 | 68 | 69 | 70 | 71 | 72 | 73 | 74 | 75 | 76 | 77 | 78 | 79 | 80 | 81 | 82 | 83 | 84 | 85 | 86 | 87 | 88 | 89 | 90 | 91 | 92 | 93 | 94 | 95 | 96 | 97 | 98 | 99 | 00 |
| COUNSELOR (SEE SUPPLEMENTAL FORM FOR CODES) | 1 | 2 | 3 | 4 | 5 | 6 | 7 | 8 | 9 | 10 | 11 | 12 | 13 | 14 | 15 | 16 | 17 | 18 | 19 | 20 | 21 | 22 | 23 | 24 | 25 | 26 | 27 | 28 | 29 | 30 | 31 | 32 | 33 | 34 | 35 | 36 | 37 | 38 | 39 | 40 | 41 | 42 | 43 | 44 | 45 | 46 | 47 | 48 | 49 | 50 | 51 | 52 | 53 | 54 | 55 | 56 | 57 | 58 | 59 | 60 | 61 | 62 | 63 | 64 | 65 | 66 | 67 | 68 | 69 | 70 | 71 | 72 | 73 | 74 | 75 | 76 | 77 | 78 | 79 | 80 | 81 | 82 | 83 | 84 | 85 | 86 | 87 | 88 | 89 | 90 | 91 | 92 | 93 | 94 | 95 | 96 | 97 | 98 | 99 | 00 |
| INTAKE DATE | 1 | 2 | 3 | 4 | 5 | 6 | 7 | 8 | 9 | 10 | 11 | 12 | 13 | 14 | 15 | 16 | 17 | 18 | 19 | 20 | 21 | 22 | 23 | 24 | 25 | 26 | 27 | 28 | 29 | 30 | 31 | 32 | 33 | 34 | 35 | 36 | 37 | 38 | 39 | 40 | 41 | 42 | 43 | 44 | 45 | 46 | 47 | 48 | 49 | 50 | 51 | 52 | 53 | 54 | 55 | 56 | 57 | 58 | 59 | 60 | 61 | 62 | 63 | 64 | 65 | 66 | 67 | 68 | 69 | 70 | 71 | 72 | 73 | 74 | 75 | 76 | 77 | 78 | 79 | 80 | 81 | 82 | 83 | 84 | 85 | 86 | 87 | 88 | 89 | 90 | 91 | 92 | 93 | 94 | 95 | 96 | 97 | 98 | 99 | 00 |
| 4. CONTACT DATE | 1 | 2 | 3 | 4 | 5 | 6 | 7 | 8 | 9 | 10 | 11 | 12 | 13 | 14 | 15 | 16 | 17 | 18 | 19 | 20 | 21 | 22 | 23 | 24 | 25 | 26 | 27 | 28 | 29 | 30 | 31 | 32 | 33 | 34 | 35 | 36 | 37 | 38 | 39 | 40 | 41 | 42 | 43 | 44 | 45 | 46 | 47 | 48 | 49 | 50 | 51 | 52 | 53 | 54 | 55 | 56 | 57 | 58 | 59 | 60 | 61 | 62 | 63 | 64 | 65 | 66 | 67 | 68 | 69 | 70 | 71 | 72 | 73 | 74 | 75 | 76 | 77 | 78 | 79 | 80 | 81 | 82 | 83 | 84 | 85 | 86 | 87 | 88 | 89 | 90 | 91 | 92 | 93 | 94 | 95 | 96 | 97 | 98 | 99 | 00 |
| PROJECTED TERMINATION DATE | 1 | 2 | 3 | 4 | 5 | 6 | 7 | 8 | 9 | 10 | 11 | 12 | 13 | 14 | 15 | 16 | 17 | 18 | 19 | 20 | 21 | 22 | 23 | 24 | 25 | 26 | 27 | 28 | 29 | 30 | 31 | 32 | 33 | 34 | 35 | 36 | 37 | 38 | 39 | 40 | 41 | 42 | 43 | 44 | 45 | 46 | 47 | 48 | 49 | 50 | 51 | 52 | 53 | 54 | 55 | 56 | 57 | 58 | 59 | 60 | 61 | 62 | 63 | 64 | 65 | 66 | 67 | 68 | 69 | 70 | 71 | 72 | 73 | 74 | 75 | 76 | 77 | 78 | 79 | 80 | 81 | 82 | 83 | 84 | 85 | 86 | 87 | 88 | 89 | 90 | 91 | 92 | 93 | 94 | 95 | 96 | 97 | 98 | 99 | 00 |

**PRETRIAL INTERVENTION PROGRAM
DEFENDANT ADMISSION FORM**

CONTACT INFORMATION

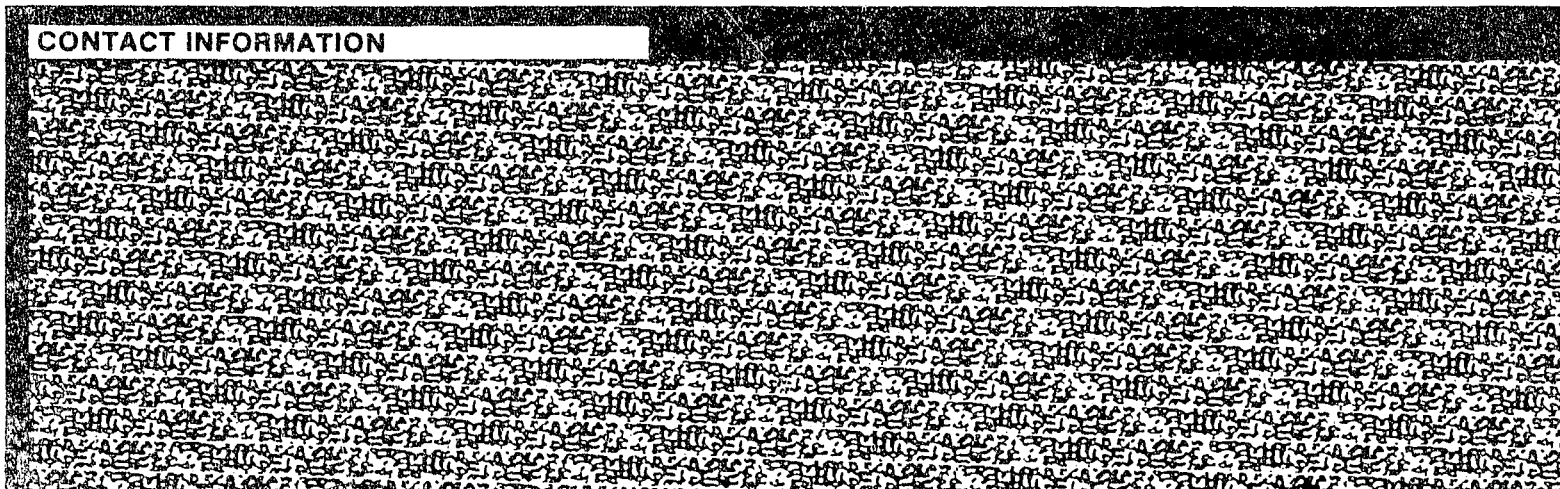

| | | | | | | | | | | | | | | | | | | | | | | | | | | | | | | | | | | | | | | | | | | | | | | | | | | | | | | | | | | | | | | | | | | | | | | | | | | | | | | | | | | | | | | | | | | | | | | | | | | | | |
|----------------------------|---|---|---|---|---|---|---|---|---|----|----|----|----|----|----|----|----|----|----|----|----|----|----|----|----|----|----|----|----|----|----|----|----|----|----|----|----|----|----|----|----|----|----|----|----|----|----|----|----|----|----|----|----|----|----|----|----|----|----|----|----|----|----|----|----|----|----|----|----|----|----|----|----|----|----|----|----|----|----|----|----|----|----|----|----|----|----|----|----|----|----|----|----|----|----|----|----|----|----|----|
| 5 D.O.B. | 1 | 2 | 3 | 4 | 5 | 6 | 7 | 8 | 9 | 10 | 11 | 12 | 13 | 14 | 15 | 16 | 17 | 18 | 19 | 20 | 21 | 22 | 23 | 24 | 25 | 26 | 27 | 28 | 29 | 30 | 31 | 32 | 33 | 34 | 35 | 36 | 37 | 38 | 39 | 40 | 41 | 42 | 43 | 44 | 45 | 46 | 47 | 48 | 49 | 50 | 51 | 52 | 53 | 54 | 55 | 56 | 57 | 58 | 59 | 60 | 61 | 62 | 63 | 64 | 65 | 66 | 67 | 68 | 69 | 70 | 71 | 72 | 73 | 74 | 75 | 76 | 77 | 78 | 79 | 80 | 81 | 82 | 83 | 84 | 85 | 86 | 87 | 88 | 89 | 90 | 91 | 92 | 93 | 94 | 95 | 96 | 97 | 98 | 99 | 00 |
| 6. AGE AT INTAKE (17 - 97) | 1 | 2 | 3 | 4 | 5 | 6 | 7 | 8 | 9 | 10 | 11 | 12 | 13 | 14 | 15 | 16 | 17 | 18 | 19 | 20 | 21 | 22 | 23 | 24 | 25 | 26 | 27 | 28 | 29 | 30 | 31 | 32 | 33 | 34 | 35 | 36 | 37 | 38 | 39 | 40 | 41 | 42 | 43 | 44 | 45 | 46 | 47 | 48 | 49 | 50 | 51 | 52 | 53 | 54 | 55 | 56 | 57 | 58 | 59 | 60 | 61 | 62 | 63 | 64 | 65 | 66 | 67 | 68 | 69 | 70 | 71 | 72 | 73 | 74 | 75 | 76 | 77 | 78 | 79 | 80 | 81 | 82 | 83 | 84 | 85 | 86 | 87 | 88 | 89 | 90 | 91 | 92 | 93 | 94 | 95 | 96 | 97 | 98 | 99 | 00 |
| 7. SS # | 1 | 2 | 3 | 4 | 5 | 6 | 7 | 8 | 9 | 10 | 11 | 12 | 13 | 14 | 15 | 16 | 17 | 18 | 19 | 20 | 21 | 22 | 23 | 24 | 25 | 26 | 27 | 28 | 29 | 30 | 31 | 32 | 33 | 34 | 35 | 36 | 37 | 38 | 39 | 40 | 41 | 42 | 43 | 44 | 45 | 46 | 47 | 48 | 49 | 50 | 51 | 52 | 53 | 54 | 55 | 56 | 57 | 58 | 59 | 60 | 61 | 62 | 63 | 64 | 65 | 66 | 67 | 68 | 69 | 70 | 71 | 72 | 73 | 74 | 75 | 76 | 77 | 78 | 79 | 80 | 81 | 82 | 83 | 84 | 85 | 86 | 87 | 88 | 89 | 90 | 91 | 92 | 93 | 94 | 95 | 96 | 97 | 98 | 99 | 00 |
| PLACE OF BIRTH | 1 | 2 | 3 | 4 | 5 | 6 | 7 | 8 | 9 | 10 | 11 | 12 | 13 | 14 | 15 | 16 | 17 | 18 | 19 | 20 | 21 | 22 | 23 | 24 | 25 | 26 | 27 | 28 | 29 | 30 | 31 | 32 | 33 | 34 | 35 | 36 | 37 | 38 | 39 | 40 | 41 | 42 | 43 | 44 | 45 | 46 | 47 | 48 | 49 | 50 | 51 | 52 | 53 | 54 | 55 | 56 | 57 | 58 | 59 | 60 | 61 | 62 | 63 | 64 | 65 | 66 | 67 | 68 | 69 | 70 | 71 | 72 | 73 | 74 | 75 | 76 | 77 | 78 | 79 | 80 | 81 | 82 | 83 | 84 | 85 | 86 | 87 | 88 | 89 | 90 | 91 | 92 | 93 | 94 | 95 | 96 | 97 | 98 | 99 | 00 |

| | |
|--|----------------------------|
| 1. DEFENDANT I.D. (CARD 1) | INTAKE DATE |
| 2. P.T.I. LOCATION (SEE SUPPLEMENTAL FORM FOR CODES) | 3. CONTRACT DATE |
| COUNSELOR (SEE SUPPLEMENTAL FORM FOR CODES) | PROJECTED TERMINATION DATE |

PRETRIAL INTERVENTION PROGRAM DEFENDANT ADMISSION FORM

| | |
|---|------------|
| CONTACT INFORMATION | |
| NAME | |
| ADDRESS | HOME PHONE |
| *(/) | *(/) |
| *(/) | WORK PHONE |
| *(/) | *(/) |
| * INSERT DATE OF CHANGE: Example (1/82) | |

| | |
|-----------|----------------------------|
| 5. D.O.B. | 6. AGE AT INTAKE (17 - 87) |
| 7. SS # | PLACE OF BIRTH |

| | |
|---------------------------|-------------------|
| SPOUSE/NEAREST CONTACT | KEEP CONFIDENTIAL |
| ADDRESS | HOME PHONE |
| | WORK PHONE |
| RELATIONSHIP TO DEFENDANT | |

| | |
|---------------------------|-------------------|
| NEAREST CONTACT | KEEP CONFIDENTIAL |
| ADDRESS | HOME PHONE |
| | WORK PHONE |
| RELATIONSHIP TO DEFENDANT | |

| | |
|-------------------|-------------------|
| FATHER | MOTHER |
| KEEP CONFIDENTIAL | KEEP CONFIDENTIAL |
| ADDRESS | ADDRESS |
| PHONE | PHONE |
| OCCUPATION | OCCUPATION |

| |
|--------------------------------|
| DEFENDANT'S SIBLINGS (AGE/SEX) |
| COMMENTS |
| |
| |
| |

SPOUSE/NEAREST CONTACT

KEEP CONFIDENTIAL

ADDRESS

HOME PHONE

WORK PHONE

RELATIONSHIP TO DEFENDANT

NEAREST CONTACT

KEEP CONFIDENTIAL

ADDRESS

HOME PHONE

WORK PHONE

RELATIONSHIP TO DEFENDANT

FATHER

MOTHER

KEEP CONFIDENTIAL

KEEP CONFIDENTIAL

ADDRESS

ADDRESS

PHONE

PHONE

OCCUPATION

OCCUPATION

DEFENDANT'S SIBLINGS (AGE/SEX)

COMMENTS

APPENDIX 2

| | | | | | | | | | | |
|--|--------|---|---|---|---|---|-----|---|---|---|
| 76. DEFENDANT I.D. <small>(SEE PAGE 1 OF ADMISSION FORM)</small> | CARD 3 | 1 | 2 | 3 | 4 | 5 | 77. | P.T. I. LOCATION <small>(SEE SUPPLEMENTAL FORM FOR CODES)</small> | 6 | 7 |
|--|--------|---|---|---|---|---|-----|---|---|---|

**PRETRIAL INTERVENTION PROGRAM
DEFENDANT RELEASE FORM**

STAFF EFFORT INFORMATION

| | |
|---|-------|
| 78. DEFENDANT REFERRED FOR COUNSELING <small>(INCLUDE ANY COUNSELING LISTED IN "CONDITION AND TREATMENT COMPLIANCE" SECTION) (0 = NO; 1 = INTRA-OFFICE REFERRAL (PTIP); 2 = OUTSIDE AGENCY(S); 3 = BOTH INSIDE AND OUTSIDE AGENCY(S))</small> | 8 |
| 79. TYPE OF PRIMARY VICTIM <small>(0 = NO VICTIM; 1 = BUSINESS; 2 = PRIVATE INDIVIDUAL; 3 = PUBLIC OFFICIAL/AGENCY)</small> | 9 |
| 80. NUMBER CONTACTS WITH VICTIM <small>00 = NONE; 97 = 97 + ; 98 = NO VICTIM</small> | 10 11 |
| 81. NUMBER TELEPHONE CONTACTS WITH DEFENDANT (include attempted) <small>(00 = None; 97 = 97 +)</small> | 12 13 |
| 82. NUMBER FACE-TO-FACE CONTACTS WITH DEFENDANT <small>(00 = None; 97 = 97 +)</small> | 14 15 |
| 83. NUMBER WRITTEN CONTACTS WITH DEFENDANT <small>(00 = None; 97 = 97 +)</small> | 16 17 |

CONDITION & TREATMENT COMPLIANCE

| | | | | | | | |
|--|----|----|----|----|---|---|----|
| 84. TOTAL HOURS COMMUNITY VOLUNTEER WORK COMPLETED. <small>(9998 = N/A, no volunteer work required)</small> | 18 | 19 | 20 | 21 | 85. COMMUNITY SERVICE WAIVED <small>(0 = No; 1 = yes; 8 = N/A, none required)</small> | 22 | |
| 86. AMOUNT OF MONETARY RESTITUTION PAID <small>(99998 = N/A, no restitution required)</small> | 23 | 24 | 25 | 26 | 27 | 87. MONETARY RESTITUTION WAIVED <small>(0 = No; 1 = yes; 8 = N/A, none required)</small> | 28 |
| 88. EXTENT OF EDUCATION REQUIREMENT COMPLETED OR ADEQUATE PROGRESS MADE TOWARD COMPLETION. <small>(0 = None; 1 = partially completed; 2 = all completed; 3 = more than required completed; 8 = N/A, none required)</small> | 29 | | | | | 89. EDUCATION WAIVED <small>(0 = No; 1 = yes; 8 = N/A, none required)</small> | 30 |
| 90. CAREER COUNSELING COMPLETED <small>(0 = None; 1 = partially completed; 2 = all completed; 3 = more than required completed; 8 = N/A, none required)</small> | 31 | | | | | 91. CAREER COUNSELING WAIVED <small>(0 = No; 1 = yes; 8 = N/A, none required)</small> | 32 |
| 92. PSYCHOLOGICAL GROUP COUNSELING COMPLETED <small>(0 = None; 1 = partially completed; 2 = all completed; 3 = more than required completed; 8 = N/A, none required)</small> | 33 | | | | | 93. PSYCHOLOGICAL GROUP COUNSELING WAIVED <small>(0 = No; 1 = yes; 8 = N/A, none required)</small> | 34 |
| 94. PSYCHOLOGICAL INDIVIDUAL COUNSELING COMPLETED <small>(0 = None; 1 = partially completed; 2 = all completed; 3 = more than required completed; 8 = N/A, none required)</small> | 35 | | | | | 95. PSYCHOLOGICAL INDIVIDUAL COUNSELING WAIVED <small>(0 = No; 1 = yes; 8 = N/A, none required)</small> | 36 |
| 96. DRUG COUNSELING COMPLETED <small>(0 = None; 1 = partially completed; 2 = all completed; 3 = more than required completed; 8 = N/A, none required)</small> | 37 | | | | | 97. DRUG COUNSELING WAIVED <small>(0 = No; 1 = yes; 8 = N/A, none required)</small> | 38 |
| 98. ALCOHOL COUNSELING COMPLETED <small>(0 = None; 1 = partially completed; 2 = all completed; 3 = more than required completed; 8 = N/A, none required)</small> | 39 | | | | | 99. ALCOHOL COUNSELING WAIVED <small>(0 = No; 1 = yes; 8 = N/A, none required)</small> | 40 |
| 100. DOMESTIC VIOLENCE COUNSELING COMPLETED <small>(0 = None; 1 = partially completed; 2 = all completed; 3 = more than required completed; 8 = N/A, none required)</small> | 41 | | | | | 101. DOMESTIC VIOLENCE COUNSELING WAIVED <small>(0 = No; 1 = yes; 8 = N/A, none required)</small> | 42 |
| 102. EXTENT TO WHICH DEFENDANT MAINTAINED EMPLOYMENT <small>(0 = No effort to maintain employment; 1 = insufficient; 2 = sufficient; 8 = N/A, not a condition.)</small> | 43 | | | | | 103. EXTENT TO WHICH DEFENDANT SOUGHT EMPLOYMENT <small>(0 = No effort to seek employment; 1 = insufficient 2 = sufficient; 8 = N/A, not a condition)</small> | 44 |

| | | | | | | | | | |
|--|--------|---|---|---|---|-----|---|---|---|
| 76. DEFENDANT I.D. <small>(SEE PAGE 1 OF ADMISSION FORM)</small> | CARD 3 | 1 | 2 | 3 | 4 | 5 | 77. P.T. I. LOCATION <small>(SEE SUPPLEMENTAL FORM FOR CODES)</small> | 6 | 7 |
| DEFENDANTS NAME | | | | | | DOB | | | |
| ACTUAL TERMINATION DATE | | | | | | SS# | | | |

PRETRIAL INTERVENTION PROGRAM DEFENDANT RELEASE FORM

STAFF EFFORT INFORMATION

| | | |
|---|----|----|
| 78. DEFENDANT REFERRED FOR COUNSELING <small>(INCLUDE ANY COUNSELING LISTED IN "CONDITION AND TREATMENT COMPLIANCE" SECTION) (0 = NO; 1 = INTRA-OFFICE REFERRAL (PTIP); 2 = OUTSIDE AGENCY(S); 3 = BOTH INSIDE AND OUTSIDE AGENCY(S))</small> | 8 | |
| 79. TYPE OF PRIMARY VICTIM <small>(0 = NO VICTIM; 1 = BUSINESS; 2 = PRIVATE INDIVIDUAL; 3 = PUBLIC OFFICIAL/AGENCY)</small> | 9 | |
| 80. NUMBER CONTACTS WITH VICTIM <small>00 = NONE; 97 - 97 + ; 98 = NO VICTIM</small> | 10 | 11 |
| 81. NUMBER TELEPHONE CONTACTS WITH DEFENDANT (include attempted) <small>(00 = None; 97 = 97 +)</small> | 12 | 13 |
| 82. NUMBER FACE-TO-FACE CONTACTS WITH DEFENDANT <small>(00 = None; 97 = 97 +)</small> | 14 | 15 |
| 83. NUMBER WRITTEN CONTACTS WITH DEFENDANT <small>(00 = None; 97 = 97 +)</small> | 16 | 17 |

CONDITION & TREATMENT COMPLIANCE

| | | | | | | | |
|--|----|----|----|----|---|---|----|
| 84. TOTAL HOURS COMMUNITY VOLUNTEER WORK COMPLETED. <small>(9998 = N/A, no volunteer work required)</small> | 18 | 19 | 20 | 21 | 85. COMMUNITY SERVICE WAIVED <small>(0 = No; 1 = yes; 8 = N/A, none required)</small> | 22 | |
| 86. AMOUNT OF MONETARY RESTITUTION PAID <small>(99998 = N/A, no restitution required)</small> | 23 | 24 | 25 | 26 | 27 | 87. MONETARY RESTITUTION WAIVED <small>(0 = No; 1 = yes; 8 = N/A, none required)</small> | 28 |
| 88. EXTENT OF EDUCATION REQUIREMENT COMPLETED OR ADEQUATE PROGRESS MADE TOWARD COMPLETION. <small>(0 = None; 1 = partially completed; 2 = all completed; 3 = more than required completed; 8 = N/A, none required)</small> | 29 | | | | | 89. EDUCATION WAIVED <small>(0 = No; 1 = yes; 8 = N/A, none required)</small> | 30 |
| 90. CAREER COUNSELING COMPLETED <small>(0 = None; 1 = partially completed; 2 = all completed; 3 = more than required completed; 8 = N/A, none required)</small> | 31 | | | | | 91. CAREER COUNSELING WAIVED <small>(0 = No; 1 = yes; 8 = N/A, none required)</small> | 32 |
| 92. PSYCHOLOGICAL GROUP COUNSELING COMPLETED <small>(0 = None; 1 = partially completed; 2 = all completed; 3 = more than required completed; 8 = N/A, none required)</small> | 33 | | | | | 93. PSYCHOLOGICAL GROUP COUNSELING WAIVED <small>(0 = No; 1 = yes; 8 = N/A, none required)</small> | 34 |
| 94. PSYCHOLOGICAL INDIVIDUAL COUNSELING COMPLETED <small>(0 = None; 1 = partially completed; 2 = all completed; 3 = more than required completed; 8 = N/A, none required)</small> | 35 | | | | | 95. PSYCHOLOGICAL INDIVIDUAL COUNSELING WAIVED <small>(0 = No; 1 = yes; 8 = N/A, none required)</small> | 36 |
| 96. DRUG COUNSELING COMPLETED <small>(0 = None; 1 = partially completed; 2 = all completed; 3 = more than required completed; 8 = N/A, none required)</small> | 37 | | | | | 97. DRUG COUNSELING WAIVED <small>(0 = No; 1 = yes; 8 = N/A, none required)</small> | 38 |
| 98. ALCOHOL COUNSELING COMPLETED <small>(0 = None; 1 = partially completed; 2 = all completed; 3 = more than required completed; 8 = N/A, none required)</small> | 39 | | | | | 99. ALCOHOL COUNSELING WAIVED <small>(0 = No; 1 = yes; 8 = N/A, none required)</small> | 40 |
| 100. DOMESTIC VIOLENCE COUNSELING COMPLETED <small>(0 = None; 1 = partially completed; 2 = all completed; 3 = more than required completed; 8 = N/A, none required)</small> | 41 | | | | | 101. DOMESTIC VIOLENCE COUNSELING WAIVED <small>(0 = No; 1 = yes; 8 = N/A, none required)</small> | 42 |
| 102. EXTENT TO WHICH DEFENDANT MAINTAINED EMPLOYMENT <small>(0 = No effort to maintain employment; 1 = insufficient; 2 = sufficient; 8 = N/A, not a condition.)</small> | 43 | | | | | 103. EXTENT TO WHICH DEFENDANT SOUGHT EMPLOYMENT <small>(0 = No effort to seek employment; 1 = insufficient; 2 = sufficient; 8 = N/A, not a condition.)</small> | 44 |

PRETRIAL INTERVENTION PROGRAM DEFENDANT RELEASE FORM

CONDITION & TREATMENT COMPLIANCE (CONTINUED)

J4. EXTENT TO WHICH DEFENDANT MAINTAINED
PRESCRIBED PTI CONTACT.

45

(0 = None; 1 = insufficient;
2 = sufficient; 3 = more than required;
8 = N/A, no contact required)

105. PTI CONTACT WAIVED

46

(0 = No; 1 = yes;
8 = N/A, no contact required)

REASONS FOR ANY WAIVED CONDITIONS:

INTER-AGENCY REFERRAL INFORMATION

106. NAME OF AGENCY
(see supplemental pages
for codes)

107. NUMBER CONTACTS BETWEEN
DEFENDANT AND AGENCY
(00 = None; 97 = 97 +; 98 = N/A,
no agency referrals)

108. PURPOSE OF REFERRAL
(see supplemental pages
for codes)

109. AGENCY PROGRAM
COMPLETED
(see supplemental
pages for codes)

AGENCY 1

| | |
|--|--|
| | |
| | |
| | |
| | |

47-48

| | |
|--|--|
| | |
| | |
| | |
| | |

49-50

| | |
|--|--|
| | |
| | |
| | |
| | |

51-52

AGENCY 2

54-55

56-57

58-59

AGENCY 3

61-62

63-64

65-66

AGENCY 4

68-69

70-71

72-73

| |
|--|
| |
| |
| |
| |

53

60

67

74

110. **CARD 3** (USE CODE 3)

80

**PRETRIAL INTERVENTION PROGRAM
DEFENDANT RELEASE FORM**

CARD 4

11. DEFENDANT I.D. (SEE PAGE 1 OF ADMISSION FORM)

112. P.T. I LOCATION (SEE SUPPLEMENTAL FORM FOR CODES)

DISPOSITION INFORMATION

113. WEEKS SERVED IN PROGRAM
(000 = < 1 week; 997 = 997 +)

114. DEFENDANT'S CONTRACT EXTENDED AT SOME TIME. (0 = No; 1 = yes)

115. DEFENDENT MOVED OUT OF STATE PERMANENTLY (0 = No; 1 = yes, authorized; 2 = yes, unauthorized)

116. DEFENDANT ENTERED MILITARY (0 = No; 1 = yes)

117. PROGRAM DISPOSITION (0 = unfavorable termination for subsequent felony charge(s). 1 = unfavorable termination for subsequent misdemeanor conviction. 2 = unfavorable termination for total noncompliance to conditions. 3 = unfavorable termination for only partial compliance to conditions. 4 = favorable termination for partial compliance to conditions. 5 = favorable termination for total compliance to conditions.)

118. SUBSEQUENT CHARGE WHILE IN PROGRAM (0 = None 1 = Misdemeanor arrest 2 = Misdemeanor conviction 3 = Felony arrest 4 = Felony information/indictment 5 = Felony conviction 6 = Domestic violence, rebartering)

119. SUBSEQUENT CHARGE AT 6 MO. FOLLOW-UP (0 = None 1 = Misdemeanor arrest 2 = Misdemeanor conviction 3 = Felony arrest 4 = Felony information/indictment 5 = Felony conviction 6 = Domestic violence, rebartering)

120. SUBSEQUENT CHARGE AT 12 MO. FOLLOW-UP (0 = None 1 = Misdemeanor arrest 2 = Misdemeanor conviction 3 = Felony arrest 4 = Felony information/indictment 5 = Felony conviction 6 = Domestic violence, rebartering)

121. CRIMINAL CODE OF SUBSEQUENT CHARGE WHILE IN PROGRAM. (9999999999999999 = N/A, no subsequent charge while in program)

122. CRIMINAL CODE OF SUBSEQUENT CHARGE AT 6 MONTH FOLLOW-UP. (9999999999999999 = N/A, no subsequent charge)

123. CRIMINAL CODE OF SUBSEQUENT CHARGE AT 12 MONTH FOLLOW-UP (9999999999999999 = N/A, no subsequent charge)

124. DOMESTIC VIOLENCE INVOLVED IN SUBSEQUENT CHARGE. (0 = No; 1 = yes; 8 = N/A, no subsequent charge)

125. DOMESTIC VIOLENCE INVOLVED IN SUBSEQUENT CHARGE AT 6 MO. FOLLOW-UP. (0 = No; 1 = yes; 8 = N/A, no subsequent charge)

126. DOMESTIC VIOLENCE INVOLVED IN SUBSEQUENT CHARGE AT 12 MO. FOLLOW-UP. (0 = No; 1 = yes; 8 = N/A, no subsequent charge)

127. DISPOSITION OF SUBSEQUENT CHARGE (0 = Dismissed; 1 = Diverted; 2 = Prosecuted; 8 = N/A, no subsequent charge)

128. DISPOSITION OF SUBSEQUENT CHARGE AT 6 MO. FOLLOW-UP. (0 = Dismissed; 1 = Diverted; 2 = Prosecuted; 8 = N/A, no subsequent charge)

129. DISPOSITION OF SUBSEQUENT CHARGE AT 12 MO. FOLLOW-UP. (0 = Dismissed; 1 = Diverted; 2 = Prosecuted; 8 = N/A, no subsequent charge)

130. **CARD 4** (use code 4)

70